

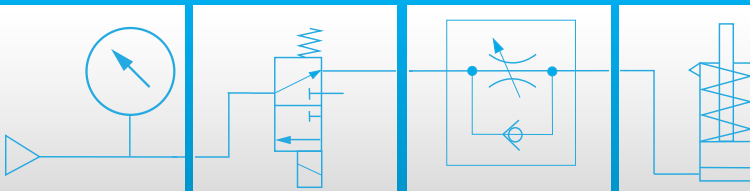

# MEAD

## Pneumatic Application & Reference Handbook



$$C_v = \frac{Q \cdot \sqrt{SG}}{\sqrt{\Delta P}}$$

Setting a new standard for:

- Useful Equations
- Application Examples
- Pneumatic Circuits
- Conversion Tables

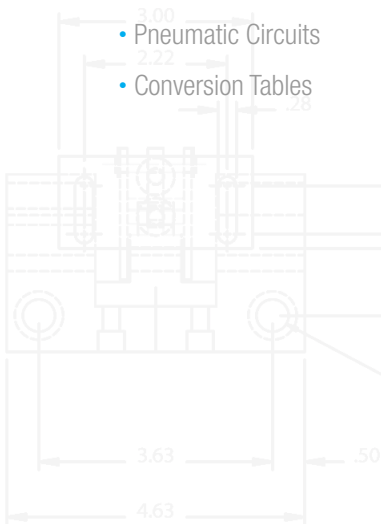

Bimba Manufacturing Company is pleased to provide this Pneumatic Application and Reference Handbook. It contains helpful information regarding fluid power application solutions. We hope you find the reference helpful.

### **Bimba Manufacturing Company**

Bimba Manufacturing is a forward-thinking innovator of actuation technology, specializing in providing cutting-edge solutions to engineering challenges. Since introducing the round line stainless steel body cylinder over five decades ago, Bimba has expanded its capabilities to include an extensive line of industry-leading air cylinders, rotary actuators, linear thrusters, rodless cylinders, flow controls and position-sensing cylinders.

The driving force behind these products is a commitment to customer satisfaction. It's a dedication to deliver more solutions, in more sizes, for more applications. Bimba's goal is to exceed performance and longevity expectations. To demonstrate this company-wide promise to provide quality products, Bimba maintains an ISO 9001 certification. The ISO standard provides a uniform framework for quality assurance that is recognized world-wide.

With a large inventory of standard catalog products for quick delivery, manufacturing facilities in several locations and an international network of stocking distributors, working with Bimba means fast, on-time delivery and superior service.



TRD provides a variety of high-quality NFPA-interchangeable cylinders and specialized cylinders while setting the benchmark in the industry for on-time delivery.



Mead is a leader in the design and development of valves, cylinders, and pneumatic components for the industrial automation market.



In addition to a broad line of standard catalog products, nearly half of Bimba's business consists of custom and semi-custom products designed for specific customers with unique applications.

## Table of Contents

Section I	5-14	Valves
	5-6	Understanding Circuit Symbols
	7	$C_v$ Defined
	8	Pneumatic Valve Sizing
	9	Valve Selection
	10-14	Frequently Asked Questions
Section II	15-29	Cylinders
	15-16	Pneumatic Actuator Types
	17	Size Selection
	18	Cylinder Mounting
	18	Cylinder Options
	19	Ambient Conditions
	19	Piston Rod Strength
	20	Pneumatic Cylinder Force
	21	Air Cylinder Speed
	22-23	Air Consumption Rates
	24-29	Frequently Asked Questions
Section III	30-32	Position Sensing
	30	Position Feedback Cylinders
	30	Closed Loop Controllers
	31	Switch Technology
	31	Proximity Switches
	31	Sinking and Sourcing
	32	Switch Hysteresis and the Operating Window
	32	Switch Troubleshooting
Section IV	33-37	Circuits
	33	Basic Control Circuits
	33	Air Circuits
	33	Timing Circuits
	33	Dual Signal Circuit
	34	Advanced Control Circuits
	34	Two Valves for Three-Position Function
	35	Two-Hand Extend One-Hand Retract
	36	Two-Hand Extend Two-Hand Retract
	37	Two-Hand Extend with Automatic Return
Section V	38	Air Filtration, Regulation, and Lubrication

Section VI	39-42	Charts
	39	Pneumatic Pipe Size
	39	Pneumatic Pressure Loss
	40	Air Flow Loss Through Pipes
	41	Pressure Loss Through Pipes
	41	Friction of Air in Hose
	42	Vacuum Flow Through Orifices
Section VII	43-46	Conversions
	43-44	Decimal Equivalents
	45	English / Metric Conversions
	45-46	English / Metric Interchange Tables:
		Torque      Force
		Length      Mass
		Area      Unit Pressure
		Volume      Velocity

The information presented should be used for reference only. Users should verify the accuracy of this information before using in their applications. Bimba is not held responsible to any inaccuracies or mis-application of the information provided.

## Understanding Circuit Symbols

Directional air control valves are the building blocks of pneumatic control. Symbols representing these valves provide a wealth of information about the valve it represents. Symbols show the methods of actuation, the number of positions, the flow paths and the number of ports. Here is a brief breakdown of how to read a symbol:

Every symbol has three parts (see figure to right). The Left and Right Actuators are the pieces which cause the valve to shift from one position to another. The Position and Flow Boxes indicate how the valve functions. Every valve has at least two positions and each position has one or more flow paths.

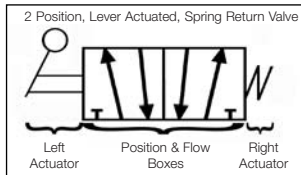

When the Lever is not activated, the Spring Actuator (right side) is in control of the valve; the box next to the actuator is the current flow path. When the Lever is actuated, the box next to the Lever is in control of the valve. Each position occurs when the attached actuator is in control of the valve (Box next to the actuator). A valve can only be in one "Position" at a given time.

The number of boxes that makes up a valve symbol indicates the number of positions the valve has. Flow is indicated by the arrows in each box. These arrows represent the flow paths the valve has when it is in that position (depending upon which actuator has control over the valve at that time).

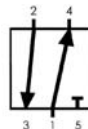

The number of ports is determined by the number of end points in a given box (only count in one box per symbol as the other boxes are just showing different states of the same valve). In the example, there are a total of 5 ports. NOTE: Sometimes a port (such as exhaust) goes directly to atmosphere and there is no port to attach to. To spot this, the actual port line will extend beyond the box, while the ports you cannot attach to will not. A Port is blocked with the symbol: 

Following is a list of symbols and what they mean:

### Valve Symbols, Flow Paths and Ports



2-Position, 2-Way, 2-Ported



2-Position, 3-Way, 3-Ported



2-Position, 4-Way, 4-Ported



2-Position, 4-Way, 5-Ported

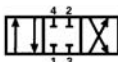

3-Position, 4-Way, 4-Ported Closed Center

### Actuator Symbols



Manual



Push Button



Lever



Foot Operated



Mechanical



Spring



Detent



Solenoid

# Section I: Valves

## Actuator Symbols



Internal Pilot



External Pilot



Piloted Solenoid with Manual Override



Piloted Solenoid and Manual Override



Lever Operated, Spring Return



Solenoid Operated, Spring Return

## Lines



Main Line



Pilot Line

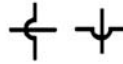

Lines Crossing

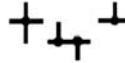

Lines Joined



Lines Joined

## Simple Pneumatic Valves



Check Valve

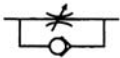

Flow Control, 1 Direction



Relief Valve

**C<sub>v</sub> Defined**

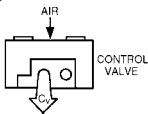

**Q:** What does “C<sub>v</sub>” mean?

**A:** Literally C<sub>v</sub> means coefficient of velocity. C<sub>v</sub> is generally used to compare flows of valves. The higher the C<sub>v</sub>, the greater the flow.

It is sometimes helpful to convert C<sub>v</sub> into SCFM (Standard Cubic Feet per Minute) and conversely, SCFM into C<sub>v</sub>. Although C<sub>v</sub> represents flow capacity at all pressures, SCFM represents flow at a specific air pressure. Therefore, the following chart relates C<sub>v</sub> to SCFM at a group of pressures.

To obtain SCFM output at a particular pressure, divide the valve C<sub>v</sub> by the appropriate factor shown below.

<b>C<sub>v</sub> to SCFM Conversion Factor Table</b>							
PSI of Air Pressure	40	50	60	70	80	90	100
Factor	.0370	.0312	.0270	.0238	.0212	.0192	.0177

**Example:** What is the output in SCFM of a valve with a C<sub>v</sub> of 0.48 when operated at 100 psi?

$$\frac{0.48 (C_v)}{.0177 \text{ (Factor)}} = \mathbf{27 \text{ SCFM}}$$

To convert SCFM into C<sub>v</sub>, simply reverse the process and multiply the SCFM by the factor.

**Pneumatic Valve Sizing**

Two methods are shown below to aid in the selection of a pneumatic valve. To account for various losses in all pneumatic systems, remember to over-size by at least 25%.

**Method 1: Calculation**

This formula and chart will give the  $C_V$  (Valve flow) required for operating a given air cylinder at a specific time period.

$$C_V = \frac{\text{Area} \times \text{Stroke} \times A \times C_f}{\text{Time} \times 29}$$

Area =  $\pi \times \text{Radius}^2$  (see table B)

Stroke = Cylinder Travel (in.)

A = Pressure Drop Constant (see table A)

$C_f$  = Compression Factor (see table A)

Time = In Seconds

**Table A**

Inlet Pressure (psi)	$C_f$ Compression Factor	"A" Constants for Various Pressure Drops		
		2 psi $\Delta P$	5 psi $\Delta P$	10 psi $\Delta P$
10	1.6		0.102	
20	2.3	0.129	0.083	0.066
30	3.0	0.113	0.072	0.055
40	3.7	0.097	0.064	0.048
50	4.4	0.091	0.059	0.043
60	5.1	0.084	0.054	0.040
70	5.7	0.079	0.050	0.037
80	6.4	0.075	0.048	0.035
90	7.1	0.071	0.045	0.033
100	7.8	0.068	0.043	0.031
110	8.5	0.065	0.041	0.030
120	9.2	0.062	0.039	0.029

**Table B**

Bore Size	Cylinder Area (Sq. In.)
1/4"	0.049
1/2"	0.196
3/4"	0.44
1-1/8"	0.99
1-1/2"	1.77
2"	3.14
2-1/4"	3.97
2-1/2"	4.91
3"	7.07
3-1/4"	8.30
4"	12.57
5"	19.64
6"	28.27
8"	50.27
10"	78.54
12"	113.10

**NOTE:** Use "A" Constant at 5 psi  $\Delta P$  for most applications. For critical applications, use "A" at 2 psi  $\Delta P$ . "A" at 10 psi  $\Delta P$  will save money and mounting space.

**Method 2: Chart**

Index  $C_V$  against Bore Size vs. Inches of stroke per second. Assuming 80 psi and  $\Delta P = 80\%$

$C_V$	Cylinder Bore Size									
	0.75	1.13	1.50	2.00	2.50	3.25	4.00	5.00	6.00	8.00
0.1	26.8	11.9	6.7	3.8	2.4	1.4	0.94	0.6	0.42	0.24
0.2	53.7	23.9	13.4	7.5	4.8	2.9	1.9	1.2	0.84	0.47
0.5	134	59.6	33.6	18.9	12.1	7.1	4.7	3	2.1	1.2
1.0	268	119	67.1	37.7	24.2	14.3	9.4	6	4.2	2.4
2.0	537	239	134	75.5	48.3	28.6	18.9	12.1	8.4	4.7
4.0		477	268	151	96.6	57.2	37.7	24.2	16.8	9.4
8.0			536	302	193	114	75.5	48.3	33.6	18.9
16.0				604	387	229	151	96.6	67.1	37.7
32.0					773	457	302	193	134	75.5



## Valve Selection

**Q:** How do I select the right valve to control a cylinder?

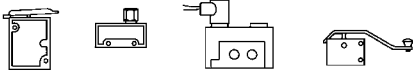

**A:** There are many factors that contribute to the performance of a cylinder. Some of these factors are: quantity and type of fittings leading to the cylinder, tube length and capacity, cylinder operating load, and air pressure.

Rather than attempting to place a value on these, and other contributing factors, it is more practical to provide valve users with a general guide to valve sizing.

The sizing table below relates various Mead air valves to cylinder bore sizes between 3/4" and 6". The cylinder operating speed resulting from the use of each valve at 80 psi is rated in general terms as:

**"F"** for High Speed Operation, **"M"** for Average Speed Operation, **"S"** for Slow Speed Operation

Valve Type	C <sub>v</sub>	Cylinder Type*	Cylinder Bore Sizes (inches)											
			3/4	1	1-1/8	1-1/2	2	2-1/4	2-1/2	3	3-1/4	4	6	
Micro-Line	0.11	SA		F					S		S			
LTV	0.18	SA, DA	F	F	F	F	M	M	M	M	S	S		
Nova	1.00	SA, DA			F	F	F	F	F	F	F	F	M	M
Dura-Matic	0.18	SA, DA	F	F	F	F	M	M	M	M	S	S		
Dura-Matic	0.63	SA, DA			F	F	F	F	F	F	M	M	M	M
Capsula	0.75	SA, DA			F	F	F	F	F	F	F	M	M	M
Capsula	3.17	SA, DA										F	F	F
FT-1, FC-1	0.13	SA		F					F		M		S	
4B-1, 4W-1	0.48	SA, DA			F	F	F	F	F	M	M	M	S	
FC51, PC51	0.81	SA							F		F		M	M
FT-101, 201	1.15	SA							F		F		F	F
Isonic® V1,V2	0.01-0.05	SA	F	M										
Isonic® V4	0.8	SA, DA			F	F	F	F	F	F	F	M	M	M
Isonic® V3	0.03-0.11	SA	F	F	F	M	S							
Isonic® V5	0.8	SA, DA			F	F	F	F	F	F	F	M	M	

\*SA = Single-Acting Cylinder, DA = Double-Acting Cylinder

Where no rating is shown, the valve is considered unsuitable for use with that particular bore size. To determine the suitability of valves not listed in the table, compare the C<sub>v</sub> of the unlisted valve with the one nearest it on the table and use that line for reference.

## Section I: Valves

### SCFM Defined

**Q:** What does SCFM mean?

**A:** SCFM means Standard Cubic Feet per Minute. “Standard” is air at sea level and at 70° F.

### Shuttle Valves

**Q:** Is there a valve that will direct air coming from either of two sources to a single destination?

**A:** Use a shuttle valve.

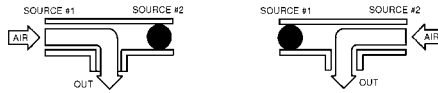

### Stacking

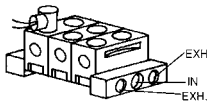

**Q:** How may I reduce piping and simplify trouble-shooting when a group of valves is used in an application?

**A:** Order your valves stacked to take advantage of a common air inlet, common exhausts, and control centralization.

### Time Delay

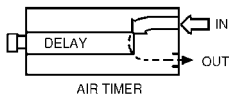

**Q:** Are there valves that allow me to delay a signal in my air circuit?

**A:** Yes, Mead air timers can be used to delay an air signal. Up to two minute normally open or normally closed models are available.

### Two-Position - vs - Three-Position

**Q:** What is the difference between two-position and three-position valves?

**A:** In two-position four-way directional valves, the two output ports are always in an opposite mode. When one is receiving inlet air, the other is connected to the exhaust port.

When actuated, three-position four-way directional valves function the same as above. However, a center or “neutral” position is provided that blocks all ports (pressure held), or connects both output ports to the exhausts (pressure released) when the valve is not being actuated.

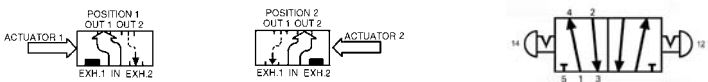

### Pressure Held Three-Position Valves

Pressure held models are ideal for “inching” operations where you want the cylinder rod to move to a desired position and then hold.

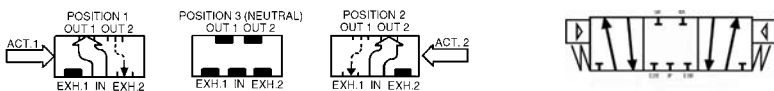

### Pressure Released Three-Position Valves



### Five-Ported Valves

**Q:** What are the advantages of a five-ported four-way valve over a four-ported four-way valve?

**A:** Five-ported valves have separate exhaust ports for each cylinder port. If exhaust silencers with built-in speed controls are used, the speed of the cylinder motion may be individually controlled in each direction.

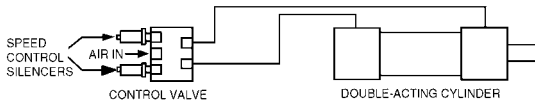

Also, five-ported valves can function as dual pressure valves where air flows from the exhaust ports to the cylinder and both cylinder ports use the inlet as a common exhaust. Vacuum may also be used in five-ported valves. Both the Mead Nova line and the Capsula line provide five-ported flow patterns.

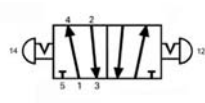
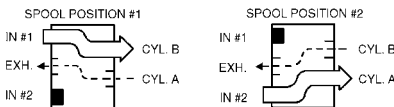

### Flow Control

**Q:** Are there valves available that provide adjustable control of air flow?

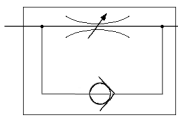

**A:** Mead Dyla-Trol™ valves perform this function. Also see the “Cylinders; Speed Control” question for application information. Dura-Matic directional valves have built-in flow controls. Exhaust silencers typically have built-in needle valves that also provide speed regulation. See the Mead catalog for more information.

### Flow Patterns, Three-Way and Four-Way

**Q:** What is the difference between a three-way and a four-way valve?

**A:** Three-way valves have one power output and four-way valves have two power outputs. Generally, three-way valves operate single-acting cylinders and four-way valves operate double-acting cylinders. For three-way and four-way valves, see the Mead Catalog MV and LTV valves, respectively.

Three-Way Flow Pattern (Normally Closed)

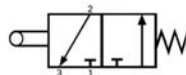
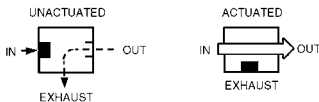

Four-Way Flow Pattern (Two Position)

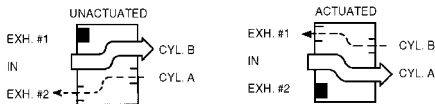

### For Safer Hand Actuation



**Q:** How may I keep the hands of my employees out of hazardous locations?

**A:** Use two-hand, anti-tiedown devices (Mead CSV).

## Air - vs - Solenoid Actuation

**Q:** What are the advantages of air actuation over solenoid actuation?

**A:** Solenoid actuation requires the presence of electric switches, wires, and all of the shielding necessary to reduce spark hazard and personal risk.

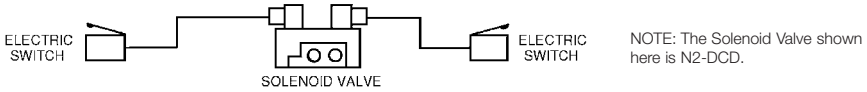

Air actuation requires only three-way air pilot valves and tubing. There is no explosion, spark, or shock risk and the components inexpensive.

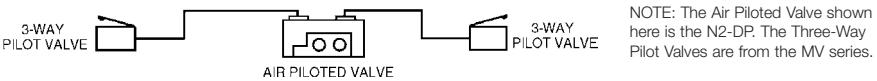

## Detented Valves

**Q:** What is a “detented” valve and how is it used?

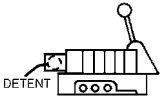

**A:** A detented valve is one that holds its position by some mechanical means such as a spring, ball or cam. Most valves hold their position by means of the natural friction of the rubber seals. Where natural friction is low, such as in packless valves, or where it is not enough for safety purposes, detented models are recommended. Also, detents are used to locate the middle position in three position valves. (See the Capsula Valve Section in the Mead Catalog.)

## Air-To-Electric Signal Conversion

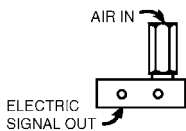

**Q:** Is it possible to convert an air signal into an electrical signal?

**A:** Mead air-to-electric switches, MPE-BZ or MPE-BZE (includes enclosure), will turn an air signal into an electrical signal, which can be wired either normally open or closed.

## Pressure Piloted - vs - Bleed Piloted

**Q:** What is the difference between pressure piloted valves and bleed piloted valves?

**A:** Pressure piloting and bleed piloting refer to two different modes in which valves may be actuated. Pressure piloting positively actuates directional valves by an external air signal that comes from a remote three-way valve, such as the Micro-Line valve series. Air pressure piloting provides an economical alternative to the use of electric switches and solenoids.



Bleed piloting uses internal air from the directional valve to feed the pilot valve. Air flows from the directional valve to the bleed valve. When the bleed valve is actuated, a pressure drop occurs in the directional valve pilot section. This causes a differential pressure and valve shift.

The main advantage of bleed piloting is that only one line enters the bleed valve. However, if the line is severed, a shift occurs. Pressure piloting is considered more positive and reliable.

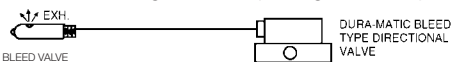

## Low Force To Actuate

**Q:** Are there valves available that require an unusually low force to actuate?



**A:** Low-stress valves need only 6-8 oz. of force to initiate a signal. These valves reduce stress on worker's hands. LTV four-way valves operate on a pressure differential basis that allows them to actuate with very little force.

## Manual Overrides

**Q:** What are manual overrides in air valves used for?

**A:** Manual overrides permit the user to actuate the directional valves without using the switches or pilot valves that would normally be used. In this way, a circuit may be tested without actually moving the machine elements.



Both Mead Capsula valves and Nova valves are available with manual overrides.

## Normally Closed - vs - Normally Open

**Q:** What is the difference between a three-way normally closed valve and a three-way normally open valve?

**A:** Normally open valves allow air to pass when **not** actuated. Normally closed valves allow air to pass only when they **are** actuated.

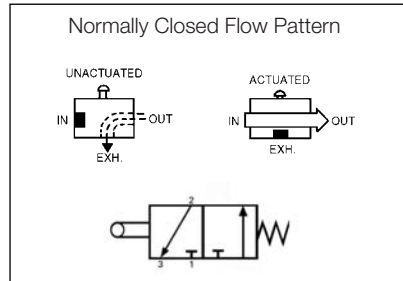
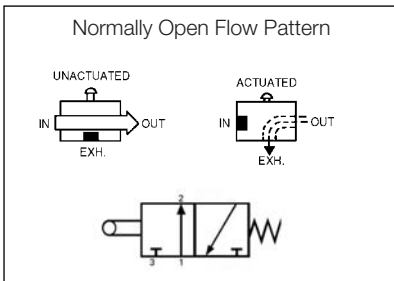

## Panel Mounted



**Q:** Are there valves available that fit through "knockouts" in control panels?

**A:** MV three-way valves and LTV four-way valves have threaded mounting stems for panels.

## External Air Supply For Solenoids

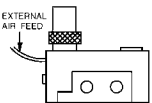

**Q:** Under what conditions should an external air supply be used to feed the solenoids on a directional valve?

**A:** When the air pressure passing through the power section of the valve is insufficient to shift the spool, when the medium passing through the power section would be detrimental to the solenoid operator, or where the operating medium could not be exhausted to the atmosphere.

### Pulse Type

**Q:** When I am using a double air piloted directional valve, how do I get the valve to shift when one of the pilots is already being charged?

**A:** Place a Mead impulse relay valve (414B) between the pilot valve and the directional valve on the side that is being rested upon.

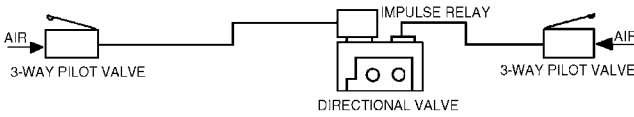

### Sound Suppression, Silencers

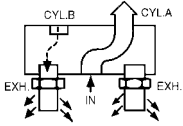

**Q:** How do I reduce the noise generated by air exhausting from a valve?

**A:** Use air silencers.

## Pneumatic Actuator Types

<p><b>Round Line</b></p> 	<p>Non-repairable cylinders have a reputation as hard-working, long-lasting, economical performers. They are available in a wide range of bore sizes, mounting styles and options. If high side or moment loads are present in the application, external guiding is required.</p>
<p><b>NFPA</b></p> 	<p>NFPA tie rod cylinders feature a durable, repairable design. They are available in a wide range of bore sizes and stroke lengths, with a variety of options.</p>
<p><b>Compact</b></p> 	<p>When space is limited, flat cylinders are a great solution. They are available in round, square, non-rotating, dual-power or three-position models.</p>
<p><b>Narrow Profile Air Tables</b></p> 	<p>The narrow profile air table actuator provides precise load guiding and high precision due to the recirculating ball rail above the cylinder bore.</p>
<p><b>Twin Bore</b></p> 	<p>Twin bore cylinders have small cross sections and two bores for double the force, with smooth operation and no rotation, and a high side load capacity.</p>
<p><b>Guided Thrusters</b></p> 	<p>An integral guiding mechanism from the cylinder manufacturer is a lower cost, immediately available alternative to home spun guide rails. Guide rods enable the cylinder to move a heavier load, prevent damage from side loads, and improve end of stroke accuracy. Extruded versions with the bore integral to the extrusion maintain their side load capacity regardless of changes in stroke.</p>
<p><b>Rodless Cylinder</b></p> 	<p>Rodless magnetically coupled cylinders use a tube similar to a round line cylinder. Strong magnets built into the piston couple the piston to magnets in the carriage which slides over the cylinder body. This design is much shorter than a round line rod type cylinder.</p>

## Section II: Cylinders

<p><b>Rodless Slide</b></p> 	<p>Bimba's rodless slides are magnetically coupled, and feature built in guides for self-guided motion with approximately 50% space savings over conventional cylinders. They are designed to handle side and moment loads. These load carrying capabilities can be increased by ordering external shock absorbers.</p>
<p><b>Rodless Band Cylinders</b></p> 	<p>Like the rodless magnetically coupled cylinders, the band cylinder saves space by using a carriage that is coupled to the piston and rides over the body of the cylinder. In this case the piston is rigidly coupled to the carriage, and rides inside the bore of the body extrusion. As the piston moves, it opens and closes a seal at the top of the cylinder. The seal works like a zipper, minimizing leakage. Compared to magnetically coupled cylinders, band types leak more, but are not subject to decoupling.</p>
<p><b>Rotary Actuators</b></p> 	<p>Rotary actuators provide rotary motion. There are two types of rotary actuators, rack and pinion and vane designs. Rack and pinion designs provide greater rotation, no external or shaft seals, high shaft loading capacity, low friction, low breakaway, and very low leakage. Vane types have no backlash, but rotation is limited to 270 degrees, the shaft seal is a wear point, and the paddle seal creates high friction.</p>
<p><b>Position Feedback</b></p> 	<p>Position feedback cylinders use sensors inside the cylinder to provide an output voltage proportional to the stroke. Feedback can be monitored to detect the presence, absence, position, or size of a part for real time process control. A closed loop controller can be used with the cylinder. The controller compares the feedback voltage to a control voltage from a PLC and adjusts pressure on either side of the piston to move the cylinder precisely into position and hold it there until the control voltage changes.</p>



## Size Selection

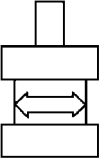

**Q:** How do I determine the correct cylinder bore size for my application?

**A:** Follow these four easy steps.

1. Weigh your load, including any base or supports, and determine the opposing force  $F$  needed to support it. Select the appropriate multiplier from the table below based on the angle of inclination of the load.

Angle	A
10°	0.17
20°	0.34
30°	0.50
40°	0.64
50°	0.77
60°	0.87
70°	0.94
80°	0.98
90°	1.0

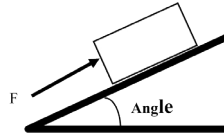

$$F = A \times (\text{Weight of load in pounds})$$

2. Increase the force as necessary to achieve the desired speed. Simply multiply  $F$  from step (1) above by  $S$  from the table below.

Speed (inches/second)	S
Up to 4	1.25
4 to 16	1.50
Above 16	2.00

$$F_s = F \times S$$

3. Select the air pressure to be supplied to the cylinder. Too high an air pressure will accelerate cylinder wear. Follow the air cylinder manufacturer's recommendations, and minimize air pressure to extend life.
4. Divide  $F_s$  from step (2) above by the air pressure in PSI. Then compare your result to the Power Factor numbers in the table below. Select a Power Factor equal to or greater than your calculated result, then read the corresponding bore size in the bottom row.

$$PF = F_s \div \text{psi}$$

Power Factor	0.07	0.15	0.25	0.40	0.60	0.90	1.2	1.7	2.4	3.1	5	7	8.3	12.5	28.3
Bore	5/16	7/16	9/16	3/4	7/8	1-1/16	1-1/4	1-1/2	1-3/4	2	2-1/2	3	3-1/4	4	6

**Example:** The load is 400 pounds. It will be moved up an incline of 50°. The load must move at 8 inches per second. What cylinder bore size is required?

1.  $F = A \times (\text{weight of load}) = .77 \times 400 = 308$
2.  $F_s = F \times S = 308 \times 1.5 = 462$
3.  $PF = F_s \div \text{psi} = \frac{462}{80} = 5.8$

Bore size required is 3 inches.

## Cylinder mounting



Pivot

**Pivot mounting** options include the **pivot, clevis, and trunnion**. They are effective in eliminating side loads in a single plane. Installation requires a rod eye or rod clevis on the piston rod, and the alignment of all pivot pins in parallel to prevent binding. Long stroke cylinders often need a stop tube or dual piston to manage bending stresses during extend and retract.

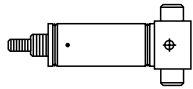

Trunnion

**Trunnion** mounts require pillow blocks or mated bearings as close as possible to the heads to minimize bending stresses. Spherical bearing pillow blocks should never be used in conjunction with trunnion mounts.

**Rigid mounting** options include **side, nose, flange, and face mounts**. If the cylinder is not perfectly aligned with the direction of travel of the load, a side load will be introduced that will cause wear and shorten cylinder life. In cases of misalignment, use either a commercial rod-end coupler with built-in axial allowance or a built-in axial take-up in the rod-end.

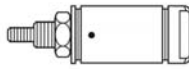

Nose Mount



Block Front

## Cylinder options

**Cushions** in either or both ends of the cylinder control deceleration and relieve impact at end of stroke, improving durability.

**Bumpers** are rubber discs that absorb impact and noise at the end of stroke, reducing noise and vibration.

**Stop tubes or dual pistons** manage side loads by distributing the forces over a larger area of the cylinder.

**Rod wipers** help keep contaminants out of the cylinder by wiping the rod as it retracts.

**Flow controls** help assure constant, controllable air flow for precise and consistent speed control regardless of variations in air pressure.

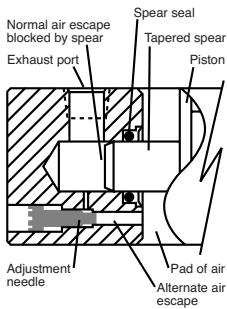

Cushion

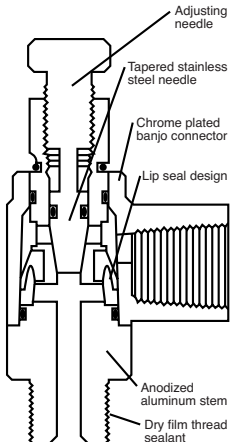

Flow Control

## Ambient Conditions

The following environmental conditions will require special cylinders or special materials.

- Operating temperature above 200° F (95° C) or below -20° F (-25° C).
- Extended operation below 0° F (-18° C)
- Radiation, caustic washdowns, water, saline, dust, and other contamination
- Inadequate maintenance and lubrication – follow manufacturer's recommendations

## Piston Rod Strength

If subjected to a heavy load, a piston rod may buckle. The following chart suggests minimum rod diameters under various load conditions when the rod is extended and unsupported, and must be used in accordance with the chart's instructions (see next paragraph). There must be no side load or bend stress at any point along the extending rod.

**HOW TO USE THE TABLE:** Exposed length of rod is shown at the top of the table. This length is typically longer than the stroke length of the cylinder. The vertical scale shows the load on the cylinder and is in English tons (1 ton = 2000 lbs.). If the rod and front end of the cylinder barrel are rigidly supported, then a smaller rod will be sufficient; use the column that is 1/2 the length of the actual piston rod. If pivot to pivot mounting is used, double the actual length of the exposed rod and utilize the suggested rod diameter.

### Figures in body of chart are suggested minimum rod diameters

Exposed Length of Piston Rod (inches)								
Pounds	10	20	40	60	70	80	100	120
2.5		1/8						
11	1/8							
14		3/16						
56	3/16							
400		7/16						
Tons	10	20	40	60	70	80	100	120
1/3		1/2						
1/2	1/4		3/4	1				
3/4	7/16		13/16	1-1/16				
1	1/2	5/8	7/8	1-1/8	1-1/4	1-3/8		
1-1/2		11/16	15/16	1-3/16	1-3/8	1-1/2		
2		3/4	1	1-1/4	1-7/16	1-9/16	1-3/16	
3	13/16	7/8	1-1/8	1-3/8	1-9/16	1-5/8	1-7/8	
4	15/16	1	1-3/16	1-1/2	1-5/8	1-3/4	2	2-1/4
5	1	1-1/8	1-5/16	1-9/16	1-3/4	1-7/8	2-1/8	2-3/8
7-1/2	1-3/16	1-1/4	1-7/16	1-3/4	1-7/8	2	2-1/4	2-1/2
10	1-3/8	1-7/16	1-5/8	1-7/8	2	2-1/8	2-7/16	2-3/4
15	1-1/16	1-3/4	1-7/8	2-1/8	2-1/4	2-3/8	2-11/16	3
20	2	2	2-1/8	2-3/8	2-1/2	2-5/8	2-7/8	3-1/4
30	2-3/8	2-7/16	2-1/2	2-3/4	2-3/4	2-7/8	3-1/4	3-1/2
40	2-3/4	2-3/4	2-7/8	3	3	3-1/4	3-1/2	3-3/4
50	3-1/8	3-1/8	3-1/4	3-3/8	3-1/2	3-1/2	3-3/4	4
75	3-3/4	3-3/4	3-7/8	4	4	4-1/8	4-3/8	4-1/2
100	4-3/8	4-3/8	4-3/8	4-1/2	4-3/4	4-3/4	4-7/8	5
150	5-3/8	5-3/8	5-3/8	5-1/2	5-1/2	5-1/2	5-3/4	6

**CAUTION:** Horizontal or angle mounted cylinders (anything other than vertical) creates a bend stress on the rod when extended, just from the weight of the rod and cylinder itself. Trunnion mounting should be utilized in a position which will balance the cylinder weight when extended.

## Pneumatic Cylinder Force

Cylinder forces are shown in pounds for both extension and retraction. Lines in standard type show extension forces, using the full piston area. Piston and rod diameters are in inches. Lines in italic type show retraction forces with various rod sizes. The valves below are theoretical, derived by calculation.

Pressures shown across the top of the chart are differential pressures across the two cylinder ports. In practice, the air supply line must supply another 5% of pressure to make up for cylinder loss, and must supply an estimated 25-50% additional pressure to make up for flow losses in lines and valving so the cylinder will have sufficient travel speed.

For all practical purposes, design your system 25% over and above your theoretical calculations.

Piston Diameter	Rod Diameter	Effec. Area Sq. In.	PSI						
			60	70	80	90	100	110	120
5/16	None	.077	4.6	5.4	6.2	6.9	7.7	8.5	9.2
	<i>.125</i>	<i>.065</i>	<i>3.9</i>	<i>4.6</i>	<i>5.2</i>	<i>5.9</i>	<i>6.5</i>	<i>7.2</i>	<i>7.8</i>
9/16	None	.248	14.9	17.4	19.8	22.3	24.8	27.3	29.8
	<i>.187</i>	<i>.221</i>	<i>13.3</i>	<i>15.5</i>	<i>17.7</i>	<i>19.9</i>	<i>22.1</i>	<i>24.3</i>	<i>26.5</i>
1-1/16	None	.886	53.2	62	70.9	79.7	88.6	97.5	106
	<i>.250</i>	<i>.837</i>	<i>50.2</i>	<i>58.6</i>	<i>67</i>	<i>75.3</i>	<i>83.7</i>	<i>92.1</i>	<i>100</i>
1-1/2	None	1.77	106	124	142	159	177	195	230
	<i>5/8</i>	<i>1.46</i>	<i>88</i>	<i>102</i>	<i>117</i>	<i>132</i>	<i>146</i>	<i>161</i>	<i>190</i>
	<i>1</i>	<i>0.99</i>	<i>59</i>	<i>69</i>	<i>79</i>	<i>89</i>	<i>98</i>	<i>108</i>	<i>128</i>
2	None	3.14	188	220	251	283	314	345	377
	<i>5/8</i>	<i>2.83</i>	<i>170</i>	<i>198</i>	<i>227</i>	<i>255</i>	<i>283</i>	<i>312</i>	<i>340</i>
	<i>1</i>	<i>2.35</i>	<i>141</i>	<i>165</i>	<i>188</i>	<i>212</i>	<i>235</i>	<i>259</i>	<i>283</i>
2-1/2	None	4.91	295	344	393	442	491	540	589
	<i>5/8</i>	<i>4.60</i>	<i>276</i>	<i>322</i>	<i>368</i>	<i>414</i>	<i>460</i>	<i>506</i>	<i>552</i>
	<i>1</i>	<i>4.12</i>	<i>247</i>	<i>289</i>	<i>330</i>	<i>371</i>	<i>412</i>	<i>454</i>	<i>495</i>
3	None	7.07	424	495	565	636	707	778	848
	<i>5/8</i>	<i>6.76</i>	<i>406</i>	<i>431</i>	<i>540</i>	<i>608</i>	<i>676</i>	<i>744</i>	<i>814</i>
3-1/4	None	8.30	498	581	664	747	830	913	996
	<i>1</i>	<i>7.51</i>	<i>451</i>	<i>526</i>	<i>601</i>	<i>676</i>	<i>751</i>	<i>826</i>	<i>902</i>
	<i>1-3/8</i>	<i>6.82</i>	<i>409</i>	<i>477</i>	<i>545</i>	<i>613</i>	<i>681</i>	<i>749</i>	<i>818</i>
4	None	12.57	754	880	1006	1131	1257	1383	1508
	<i>1</i>	<i>11.78</i>	<i>707</i>	<i>825</i>	<i>943</i>	<i>1061</i>	<i>1178</i>	<i>1296</i>	<i>1415</i>
	<i>1-3/8</i>	<i>11.09</i>	<i>665</i>	<i>776</i>	<i>887</i>	<i>998</i>	<i>1109</i>	<i>1219</i>	<i>1330</i>
5	None	19.64	1178	1375	1571	1768	1964	2160	2357
	<i>1</i>	<i>18.85</i>	<i>1131</i>	<i>1320</i>	<i>1508</i>	<i>1697</i>	<i>1885</i>	<i>2074</i>	<i>2263</i>
	<i>1-3/8</i>	<i>18.16</i>	<i>1089</i>	<i>1271</i>	<i>1452</i>	<i>1634</i>	<i>1816</i>	<i>1997</i>	<i>2179</i>
6	None	28.27	1696	1979	2262	2544	2827	3110	3392
	<i>1-3/8</i>	<i>26.79</i>	<i>1607</i>	<i>1875</i>	<i>2143</i>	<i>2411</i>	<i>2679</i>	<i>2946</i>	<i>3214</i>
	<i>1-3/4</i>	<i>25.90</i>	<i>1552</i>	<i>1811</i>	<i>2069</i>	<i>2328</i>	<i>2586</i>	<i>2845</i>	<i>3104</i>
8	None	50.27	3016	3519	4022	4524	5027	5530	6032
	<i>1-3/8</i>	<i>48.79</i>	<i>2927</i>	<i>3415</i>	<i>3903</i>	<i>4391</i>	<i>4879</i>	<i>5366</i>	<i>5854</i>
	<i>1-3/4</i>	<i>47.90</i>	<i>2872</i>	<i>3351</i>	<i>3829</i>	<i>4308</i>	<i>4786</i>	<i>5265</i>	<i>5744</i>
10	None	78.54	4712	5498	6283	7069	7854	8639	9425
	<i>1-3/4</i>	<i>76.14</i>	<i>4568</i>	<i>5329</i>	<i>6091</i>	<i>6852</i>	<i>7614</i>	<i>8375</i>	<i>9136</i>
	<i>2</i>	<i>75.40</i>	<i>4524</i>	<i>5278</i>	<i>6032</i>	<i>6786</i>	<i>7540</i>	<i>8294</i>	<i>9048</i>
12	None	113.10	6786	7917	9048	10179	11310	12441	13572
	<i>2</i>	<i>110.00</i>	<i>6598</i>	<i>7697</i>	<i>8797</i>	<i>9896</i>	<i>10996</i>	<i>12095</i>	<i>13195</i>
	<i>2-1/2</i>	<i>108.20</i>	<i>6491</i>	<i>7573</i>	<i>8655</i>	<i>9737</i>	<i>10819</i>	<i>11901</i>	<i>12983</i>

## Air Cylinder Speed

Estimating cylinder speed is extremely difficult because of the flow losses within the system in piping, fittings, and porting through the valves which are in the air path. Flow losses cause a loss in pressure which directly effect the force output. To be able to determine the maximum speed of the cylinder, the sum of all flow losses, pressure required for the force output and the available inlet pressure must be known. Circuit losses cannot be determined or calculated accurately. Rules of thumb are relied upon to determine an approximation of air cylinder speed.

The first general rule of thumb is choose a cylinder which will allow for at least 25% more force than what is required. For extremely fast operations, choose a cylinder which will allow for 50% more force than what is required. This will leave 25% or 50% of inlet pressure to satisfy system losses.

The second rule of thumb is to select a directional control valve which has the same port size as the cylinder which it will be operating. Typically, a larger valve's internal flow capacity is the same as the connection size. On smaller valves, the internal flow capacity is typically much less than the connection size. Always be sure to check the valve's flow rate and do not rely on the port size.

**NOTE:** These values are an approximate speed, under average conditions, where the force required is 50% of available 80-100 psi inlet pressure, the directional valve internal flow is equal to the porting and an unlimited supply of air. Acceleration distance is assumed to be relatively short compared to total stroke based upon sufficiently long stroke.

Estimated Cylinder Speed								
Figures below are in Inches per Second								
Actual Valve Orifice Diameter								
Bore	1/32	1/16	1/8	1/4	3/8	1/2	3/4	1
5/16	62							
9/16	19	48						
3/4	11	27						
1	6	15	37					
1-1/8	5	12	28	85				
1-1/2	3	7	16	50				
2		4	9	28	70			
2-1/2			6	18	45	72		
3			4	12	30	48		
3-1/4			3	10	24	37	79	
4				7	17	28	60	
5					4	11	18	40
6						3	7	12
8							4	7
10								4
12								3

## Estimate Travel Speed of Loaded Air Cylinder

### Air Flow Through Orifices

The chart below gives theoretical SCFM air flow through sharp edged orifices. In actual practice, approximately 2/3 of this flow is obtained. Assume 75% of line pressure (psi) is actually working on the load. The remaining 25% is consumed by flow losses in the valve and connecting lines.

Calculate 75% of your line pressure (psi) and find it in the first column in the chart below. Move across the table to the column which is the actual port size of your valve. Since valves do not contain sharp edged orifices, divide this number in half.

After finding the SCFM, convert this to CFM at the pressure required to move the load. From this the speed of travel can be estimated.

Approximate SCFM flow through Sharp Edged Orifices											
PSI Across Orifice	Orifice Diameter, in Inches										
	1/64	1/32	1/16	1/8	1/4	3/8	1/2	5/8	3/4	7/8	1
5	0.062	0.249	0.993	3.97	15.9	35.7	63.5	99.3	143	195	254
6	0.068	0.272	1.09	4.34	17.4	39.1	69.5	109	156	213	278
7	0.073	0.293	1.17	4.68	18.7	42.2	75.0	117	168	230	300
9	0.083	0.331	1.32	5.30	21.2	47.7	84.7	132	191	260	339
12	0.095	0.379	1.52	6.07	24.3	54.6	97.0	152	218	297	388
15	0.105	0.420	1.68	6.72	26.9	60.5	108	168	242	329	430
20	0.123	0.491	1.96	7.86	31.4	70.7	126	196	283	385	503
25	0.140	0.562	2.25	8.98	35.9	80.9	144	225	323	440	575
30	0.158	0.633	2.53	10.1	40.5	91.1	162	253	365	496	648
35	0.176	0.703	2.81	11.3	45.0	101	180	281	405	551	720
40	0.194	0.774	3.10	12.4	49.6	112	198	310	446	607	793
45	0.211	0.845	3.38	13.5	54.1	122	216	338	487	662	865
50	0.229	0.916	3.66	14.7	58.6	132	235	366	528	718	938
60	0.264	1.06	4.23	16.9	67.6	152	271	423	609	828	1082
70	0.300	1.20	4.79	19.2	76.7	173	307	479	690	939	1227
80	0.335	1.34	5.36	21.4	85.7	193	343	536	771	1050	1371
90	0.370	1.48	5.92	23.7	94.8	213	379	592	853	1161	1516
100	0.406	1.62	6.49	26.0	104	234	415	649	934	1272	1661
110	0.441	1.76	7.05	28.2	113	254	452	705	1016	1383	1806
120	0.476	1.91	7.62	30.5	122	274	488	762	1097	1494	1951
130	0.494	1.98	7.90	31.6	126	284	506	790	1138	1549	2023

## Air Consumption Rates

**Q:** How do I calculate the air consumption of a cylinder?

**Example:** Determine the air consumption of a 2" bore cylinder with a 4" stroke operating 30 complete cycles (out and back) per minute at 80 psi inlet pressure.

**A:**

- Find the area of the piston by converting the bore diameter into square inches.  
 $(2 \text{ in. bore}/2)^2 \times 3.1416 (\pi) = 3.14 \text{ sq. in.}$
- Determine consumption per single stroke.  
 $3.14 \text{ sq. in.} \times 4 \text{ in. stroke} = 12.56 \text{ cu. in.}$
- Determine consumption per complete cycle (disregard displacement of piston rod because it is generally not significant).  
 $12.56 \text{ cu. in.} \times 2 = 25.12 \text{ cu. in. per cycle}$
- Determine volume of 80 psi air that is consumed per minute.  
 $25.12 \text{ cu. in.} \times 30 \text{ cycles/minute} = 753.6 \text{ cu. in./min. of 80 psi air}$
- Convert cu. in. to cu. ft.  
 $\frac{753.6 \text{ cu. in./min.}}{1728 \text{ cu. in./cu. ft.}} = 0.436 \text{ cu. ft./min.}$
- Calculate compression ratio to convert "free" (uncompressed) air to compressed air at 80 psi  
 $\frac{80 \text{ psi} + 14.7 \text{ psi}}{14.7 \text{ psi}} = 6.44$  (times air is compressed when at 80 psi)
- Determine cubic feet of free air used per minute.  
 $0.436 \text{ cu. ft.} \times 6.44 \text{ compression ratio} = 2.81 \text{ cu. ft. of free air used per minute}$
- So, the consumption rate of a 2" bore, 4" stroke cylinder operating 30 complete cycles per minute at 80 psi is **2.81 SCFM** (Standard Cubic Feet Per Minute) of free air. "Standard" means at a temperature of 70° F and at sea level. Also see questions regarding  $C_v$  and cylinder size selection.

## Determine Air Volume Required

The figures in the table below are for cylinders with standard rods. The difference with over-sized rods is negligible. Air consumption was calculated assuming the cylinder would dwell momentarily at the end of each stroke, allowing air to fill up the cylinder to set system pressure. If cylinder strokes prior to allowing for air to fill, air consumption will be less than what is shown in the table.

Assuming system losses through piping and valves will be approximately 25%, make sure that the cylinder bore selected will balance the load at 75% of the pressure available in the system. Without this surplus pressure, the cylinder may not travel at its desired speed.

### Using the Table Below

Upon determining the regulator pressure, go to the proper column. The figures below represent a 1" stroke extend and retract cycle. Take the figure and multiply the actual stroke by the number of cycles needed in one minute. The result will be the SCFM for the application.

Cylinder Air Consumption: 1" Stroke, Full Cycle										
Cylinder Bore	PSI									
	60	70	80	90	100	110	120	130	140	150
5/16	0.00045	0.00051	0.00057	0.00063	0.00069	0.00075	0.00081	0.00087	0.00093	0.00099
9/16	0.00146	0.00166	0.00185	0.00205	0.00224	0.00244	0.00264	0.00283	0.00303	0.00322
1-1/16	0.00521	0.00591	0.00661	0.00731	0.00801	0.00871	0.00940	0.01010	0.01080	0.01150
1-1/2	0.009	0.010	0.012	0.013	0.015	0.016	0.017	0.018	0.020	0.021
2	0.018	0.020	0.022	0.025	0.027	0.029	0.032	0.034	0.036	0.039
2-1/2	0.028	0.032	0.035	0.039	0.043	0.047	0.050	0.054	0.058	0.062
3	0.039	0.044	0.050	0.055	0.060	0.066	0.070	0.076	0.081	0.087
3-1/4	0.046	0.053	0.059	0.065	0.071	0.078	0.084	0.090	0.096	0.102
4	0.072	0.081	0.091	0.100	0.110	0.119	0.129	0.139	0.148	0.158
5	0.113	0.128	0.143	0.159	0.174	0.189	0.204	0.219	0.234	0.249
6	0.162	0.184	0.205	0.227	0.249	0.270	0.292	0.314	0.335	0.357
8	0.291	0.330	0.369	0.408	0.447	0.486	0.525	0.564	0.602	0.642
10	0.455	0.516	0.576	0.637	0.698	0.759	0.820	0.881	0.940	1.000
12	0.656	0.744	0.831	0.919	1.010	1.090	1.180	1.270	1.360	1.450

Example: What is the SCFM of a cylinder in a stamping application that moves a 2250 lbs. weight 60 times per minute through a 6" stroke?

By selecting a 6" bore, the 2250 lbs. force is realized at 80 psi. Then add 25% more pressure (20 psi) to account for system losses and set the regulator at 100 psi. Then using the table above, we have the following calculation:

$$0.249 \times 6 \text{ (stroke)} \times 60 \text{ (cycles per minute)} = 89.64 \text{ SCFM}$$

### Double-Acting - vs - Single-Acting

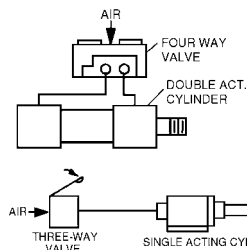

**Q:** What are the differences between double-acting and single-acting cylinders?

**A:** Double-acting cylinders provide power on both the “extend” and “retract” stroke. They require the use of four-way directional control valves.

Single-acting cylinders provide power only on the “push” stroke. The piston rod is returned by an internal spring. Single-acting cylinders use about one-half as much air as double-acting cylinders and are operated by three-way valves.

NOTE: Valves shown here are from the Mead Nova Series (four-way valve) and the MV Series (three-way valve).

### Force Output Calculation

**Q:** How do I figure out the theoretical force output of a cylinder?

**A:** Follow these steps.

1. Calculate the area of the cylinder piston.

$$\text{Area} = \pi r^2$$

where  $\pi = 3.1416$   
 $r = 1/2$  the bore diameter

2. Multiply the piston area by the air pressure to be used.

$$\text{Area} \times \text{Pressure} = \text{Force Output}$$

**Example:** What is the theoretical force output of a 2-1/2" bore cylinder operating at 80 lbs. per square inch air pressure?

Step 1.  $\text{Area} = \pi r^2$   $\text{Area} = 3.1416 \times 1.25^2$   
 $\text{Area} = 4.91$  square inches

Step 2.  $4.91 \text{ sq. in.} \times 80 \text{ psi} = 393 \text{ lbs. of force}$

Note: The force output on the rod end of a cylinder will be slightly less due to the displacement of the rod. The real force output of a cylinder will be less than the theoretical output because of internal friction and external side loading. It is best to use a cylinder that will generate from 25% to 50% more force than theoretically needed.

### Mid-Stroke Position Sensing

**Q:** How do I sense the position of a cylinder piston when it is somewhere between its limits?

**A:** Order your cylinder with solid state or reed switches and a magnetic piston. Set the switches at the desired trip points. An electrical signal will be emitted when the magnetic piston passes a switch.

### Non Lubricated

**Q:** Are there cylinders available that do not require lubrication?

**A:** Some cylinders have Teflon® seals that glide over the cylinder tube surface without the aid of a lubricant. Other cylinders often have a “non-lube” option.

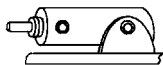



## Smoother Cylinder Motion

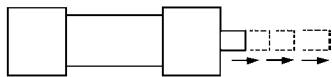

**Q:** What could cause a cylinder to move erratically during stroking?

**A:** Irregular rod motion could be caused by:

1. Too low an input air pressure for the load being moved.
2. Too small a cylinder bore size for the load being moved.
3. Side loading on the cylinder rod caused by misalignment of the rod and load.
4. Using flow control valves to meter the incoming air rather than the exhausting air.
5. Flow control valves are set for too slow a rod movement.
6. An absence of lubrication.

## Speed Boost

**Q:** How do I get more speed out of a cylinder?

**A:** You may increase the inlet pressure to within the recommended limits and/or you may place a quick exhaust valve in either or both cylinder port(s).

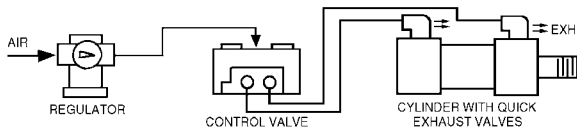

## Speed Control

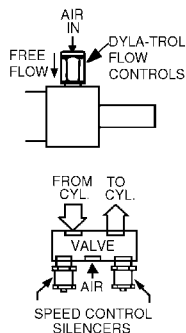

**Q:** How can I control cylinder speed?

**A:** Use any of the following methods:

1. Place Mead Dyla-Trol™ flow control valves in each cylinder port. Install them so that the air leaving the cylinder is controlled.
2. Use right-angle flow controls in the cylinder ports. These feature a recessed screw driver adjustment and convenient swivel for ease of tubing alignment.
3. Place speed control silencers into the exhaust ports of the control valve that is being used to power the cylinder.
4. Purchase a directional valve that has built-in flow controls. See Mead Dura-Matic Valves.
5. Use a position feedback cylinder with a closed loop controller. See Page 7, Flow Controls.

## Cushioning

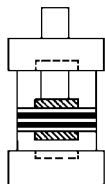

**Q:** How do I prevent a cylinder from impacting at the end of its stroke?

**A:** Generally, it is best to order your cylinders with built-in cushions if you anticipate unacceptable end-of-stroke impact. Cushions decelerate the piston rod through the last 11/16" of stroke. The degree of cushioning may be adjusted by means of a needle control in the cylinder head.

### Sensing Cylinder Position

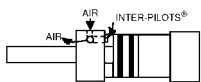

**Inter-Pilots™:** all-pneumatic, positive end-of-stroke cylinder position sensing. Available on all Mead square-head cylinders.

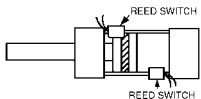

**Magnetically-operated sensors:** Electrical switches are activated by a piston-mounted magnet, thereby sending a signal that the cylinder has reached that position.

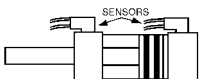

**Pneumatic end-of-stroke sensors:** port-mounted pneumatic sensors that send an output air signal when cylinder direction changes.

### Continuous Feedback:

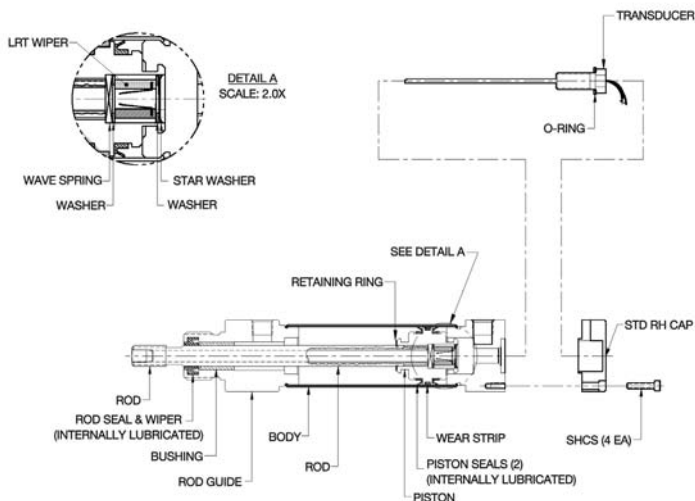

When positioning is infinite or variable depending on a process, or when the absolute position of a cylinder needs to be measured other than at end of stroke, position feedback cylinders represent a complete solution. Sensors inside the cylinder provide an output voltage proportional to the stroke. The feedback voltage can be monitored as a direct reading of the position of the piston. Closed loop controllers can be used with position feedback cylinders for accurate positioning in response to a control voltage input. For more information refer to section III, Closed Loop Position Control and Feedback. (Bimba PFC, PTF, PFCN, and PCS).

It is easy to estimate the output voltage produced when the rod extends a given distance.

Example: A position feedback cylinder with a 9 inch stroke is used in a dancer arm assembly. Ten volts is applied across the probe. What is the output voltage when the rod extends 3.6 inches?

$$\frac{\text{output voltage}}{\text{total voltage applied}} = \frac{\text{inches extended}}{\text{total stroke}}$$

$$\frac{x \text{ volts}}{10 \text{ volts}} = \frac{3.6 \text{ inches}}{9 \text{ inches}}$$

$$x = 4 \text{ volts}$$

## Increasing Power

**Q:** How do I get more power out of a particular cylinder?

**A:** You should increase the pressure of the air that feeds the cylinder within the recommended limits.

## Pressure Maintenance

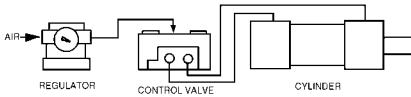

NOTE: The Control Valve shown here is from the Mead Nova Series.

**Q:** How do I maintain a constant cylinder force output when my air pressure supply fluctuates?

**A:** Set an air regulator ahead of your valve at a pressure that may always be maintained.

**Example:** Depending on the time of day and workload, a plant's air pressure fluctuates between 80 and 95 psi. Set the regulator at 80 psi and the cylinder power output through the plant will remain constant. Also, an air reservoir may be used to solve an air shortage problem. By mounting a reservoir close to a cylinder, an adequate amount of air will be supplied when needed.

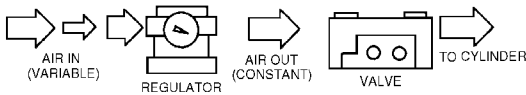

## Reciprocating

**Q:** How do I get a cylinder to reciprocate automatically?

**A:** Order your cylinder with Inter-Pilots™, solid state or reed switches, or stroke completion sensors. These devices will send signals to double pressure or solenoid operated valves that will shift each time a stroke has been completed. Reciprocation may also be achieved by having a cam mounted on the cylinder rod that trips an external limit valve.

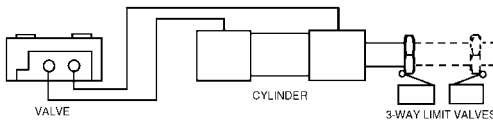

NOTE: The Valve shown here is from the Mead Nova Series. The 3-Way Limit Valves are from the MV series.

### Adjustable Stroke

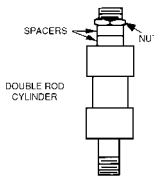

**Q:** Is it possible to make the stroke of a cylinder adjustable?

**A:** Yes. Double-acting cylinders may be ordered with a common rod that protrudes from both cylinder end caps. A nut may be placed on one rod-end to retain spacers that will limit the stroke distance. Be sure to guard the spacer end because “pinch points” will be present.

### Single-rod - vs - Double-rod

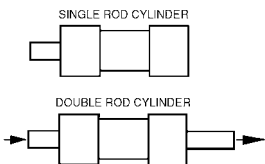

**Q:** What's the difference between single-rod and double-rod cylinders?

**A:** Single-rod cylinders have a piston rod protruding from only one end of the cylinder. Double-rod cylinders have a common rod, driven by a single piston, protruding from both cylinder end caps. When one end retracts, the other extends. They are excellent for providing an adjustable stroke and additional rigidity. Also, a double-rod with attached cam may be used to trip a limit switch.

### Space Saving Type

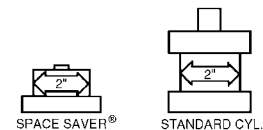

**Q:** I have a space problem and cannot fit a regular cylinder into the area available. What can I do?

**A:** Use the ultra-compact Bimba Flat, Extruded Flat, or Mead “Space-Saver®” cylinder.

### Side Load Reduction

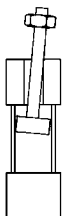

**Q:** How may I minimize the adverse effects of cylinder side loading?

**A: First**, be sure that the object being moved is in exact alignment with the piston rod. If the cylinder is rigidly mounted and the rod is forced off line, the cylinder bearing will wear prematurely and a loss of power will occur. It may be helpful to use guide rails to keep the object being moved in proper alignment. **Second**, don't use all of the stroke. Particularly on pivot and clevis models, it is wise to have the piston stop a few inches short of full stroke. This makes the cylinder more rigid and extends bearing life. **Third**, order your cylinder with an external bearing.

An external bearing takes advantage of physics by providing more bearing surface and a longer lever point than a standard cylinder type. **Fourth**, order a self aligning rod coupler.

The table on the right shows the rod couplers that Bimba offers. The thread shown is a male/female thread as the coupler has both a male and female end.

Rod Couplers	
Part Number	Rod Thread
AC5-40	#5-40
AC8-32	#8-32
AC10-32	#10-32
AC250	1/4"-28
AC312	5/16"-24
AC375	3/8"-24
AC437	7/16"-20
AC500	1/2"-20
AC625	5/8"-18
AC750	3/4"-16
AC875	7/8"-14
AC1000	1"-14

## High Temperature Operations



**Q:** I have an application in a high temperature environment. What should I do to avoid complications?

**A:** The control valve powering the cylinder should be mounted as far away from the heat as possible. While temperatures exceeding 212° F (100° C) can cause breakdown in Buna N seals, most cylinders may be supplied with fluorocarbon seals instead of Buna N. Fluorocarbon seals are effective to 400° F (204° C). Fluorocarbon seals are also known as Viton seals.

## Non-Lubricated Air Circuit



**Q:** Is it possible to build an air circuit using components that do not require lubrication?

**A:** Mead Micro-Line pilot valves (MV), Capsula directional valves, and Centaur cylinders will provide excellent service without lubrication. Most Mead cylinders are available with optional non-lube seals.

## Cylinder Presses, Non-Rotating

**Q:** How do I prevent the tooling attached to my air press rod from turning?

**A:** Order the press cylinder with a non-rotating rod. (Bimba NR Series)



## Collet Fixtures

**Q:** Is there a way of firmly holding smooth round bars with an air powered device?

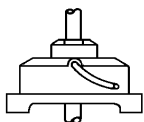

**A:** Use an air collet fixture. The device operates just like a double acting cylinder; air to close and open. The collet fixture uses standard industrial collets and can handle round or hex bars.

Mead offers a 5C and 3C collet fixture (Mead Models LS-1 and PCF).

## Closed Loop Position Control and Feedback

### Position Feedback Cylinders

The PFC defines the position of a machine fixture or tool relative to a part moving through the process. Applications include reusable or reconfigurable automation, adapting to multiple products, product lines, or assembly processes and adjusting to shifting demand and shorter product life cycles. This results in producing greater variety, altering a mix of options or features, and minimizing changeover time and cost.

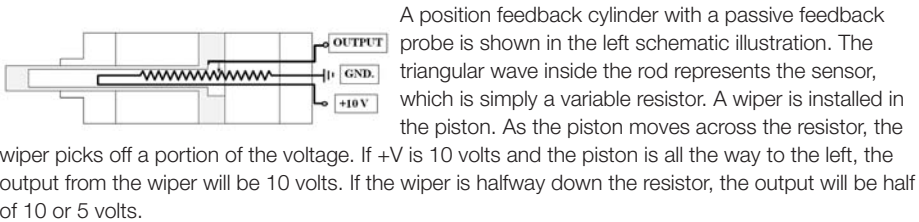

The PFC is designed to operate using clean, dry, non-lubricated air. Moisture, dirt, and lubricants, especially silicon, shorten life. In moist or dirty environments, filters and desiccant driers must be used. Fittings should be air tight. The feedback signal from the PFC must be shielded, and the DC voltage supplied must be free of noise and well regulated. Any electrical noise on the low voltage feedback signal will cause erratic readings.

When environmental and air line conditions are less than optimum, a cylinder with an active probe is the best choice, such as the magnetostrictive probe used in Bimba PFCN cylinders. It uses electronics to produce a feedback voltage. There are no wipers or mechanical parts to wear, regardless of the presence of moisture or contaminants. The principal is the same. The probe's electronics require 24 VDC power, and as the piston moves, the output voltage varies from 0 fully retracted to 10 volts fully extended.



For measuring and gauging, a panel meter like the one illustrated on the left will provide a direct readout of the probe's voltage. The meter can be scaled to read in inches or millimeters rather than volts.

### Closed Loop Controllers

A closed loop pneumatic cylinder controller has electronics that compare a control voltage to the position feedback cylinder's feedback voltage, and then meters air pressure to both sides of the piston until the feedback and control voltages are equal.



The inputs to the box are a 0-10 VDC command signal, 24 VDC power, 80 psi air, and the feedback voltage from the probe. The unit's electronically controlled valves move the piston in response to the command signal, and hold the piston in position.

## Switch Technology

**Magnetic reed switches:** Magnetic reed switches have internal contacts that close in the presence of a magnetic field.

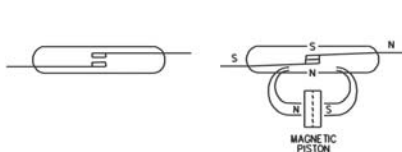

Reed switches are cheap, compact, and easy to mount. They operate off AC or DC voltages. LED's in the switch body simplify set-up and troubleshooting. Triac output is required for very high currents. It is important to know the voltage and current ratings for your switch, and the voltage and current draws of any loads you connect to the switch. High current draws can destroy the switch.

**Solid state (electronic) switches:** Today most solid state switches use GMR 'Giant Magneto-Resistive' technology. These three-wire solid state switches contain GMR resistors. Their resistance drops in presence of magnetic fields, and as a result a comparator circuit switches output. They are ideal for use with PLC's and any other low current DC loads. Compared to reed switches GMR switches have some key advantages. They switch more symmetrically; we say they have balanced windows. They are fast acting and fault tolerant, with over-voltage and reverse polarity protection.

## Proximity Switches



Proximity switches do not react to magnetic fields. They close as metal approaches. The inductance of a coil inside the sensor changes and electronics cause the switch to close.

## Sinking and Sourcing

Most solid state switches are specified as either sinking or sourcing. Correct use requires that sinking switches connect the load to ground, and sourcing switches connect the load to power. If sinking or sourcing operation is unknown or cannot be determined, Bimba provides an MS "auto-configure" switch that senses how it is being applied, and then configures itself for the application. It eliminates guesswork and helps ensure a successful application.

Sinking switches connect the load to ground.

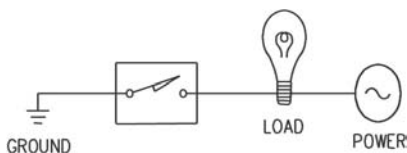

Sourcing switches connect the load to power.

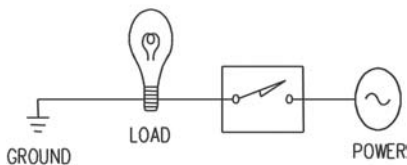

### Switch Hysteresis and the Operating Window

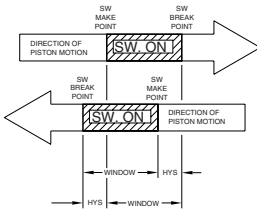

The window is the distance of travel over which the switch is on. It can be smaller or larger depending on direction. Make points and break points can be different because of hysteresis – the change in magnetic field strength needed to activate a switch. A switch may not react immediately to a magnetic field. It may react slowly, and operation may not be symmetrical.

### Switch Troubleshooting

- Verify power applied in your circuit before selecting a switch. Measure current draw and select a switch with a current capacity that exceeds the current you measured. If you are uncertain, order the switch with the highest rating.
- Bench test: test your circuit before installing in a machine.
- A cylinder must have a magnetic piston in order to use a reed or solid state magnetic switch.
- DO NOT test your switch by connecting it directly to a battery. When a magnet field closes the switch, the battery will be producing current into a short circuit, and for a short time a large current will flow which will in most cases destroy your switch. Always test your switch with a current limiting resistor, or use a bench power supply and limit the current to half the maximum rating of the switch.

Always test your switch with a current limiting resistor, or use a bench power supply and limit the current to half the maximum rating of the switch.



## Basic Control Circuits

### Air Circuitry

**Q:** What is a typical air circuit?

**A:** The simplest and most common air circuit consists of a double-acting cylinder which is controlled by a four-way directional valve. The directional valve is actuated by air pilot valves or electric switches.

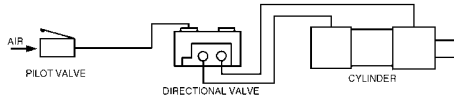

### Timing Circuits

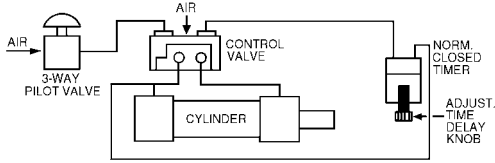

#### Sample Mead Components

3-Way Air Pilot - MV-140  
Control Valve - N2-DP  
Normally Closed Timer - KLC-105

In this circuit, the three-way valve is actuated and air is sent to the control valve. The control valve shifts, sending air to the rear of the cylinder causing the cylinder to extend. Air also flows to the timer where it begins to fill to the pre-set volume. Once reached, the timer opens, allowing the air to flow through to the control valve's other pilot port, shifting the valve back. Air flows through port B, retracting the cylinder.

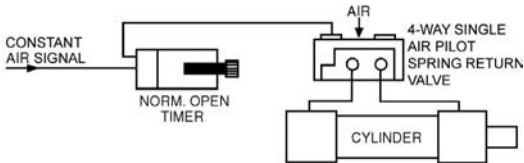

#### Sample Mead Components

Normally Open Timer - KLH-105  
Control Valve - N2-SP

In this circuit a constant air signal is sent to the timer. The normally open timer allows air to flow through until the set time period expires. While air flows to the pilot of the control valve the cylinder extends and remains extended. When the time period expires, the cylinder returns even if the air signal remains. NOTE: In this set-up, if the air signal is removed before the timer, the cylinder will retract. The circuit will only re-cycle once the air signal is removed and re-applied.

### Dual Signal Circuit

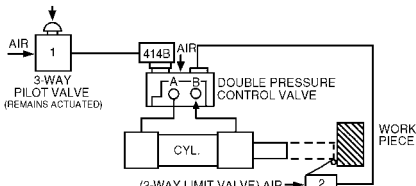

#### Sample Mead Components

3-Way Pilot Valve - MV-140  
Control Valve - N2-DP  
Impulse Relay - 414B  
3-Way Limit Valve - MV-15

When actuated, the three-way valve sends a signal to 414B, which emits a signal to the control valve. The three-way valve remains actuated. The valve shifts, allowing air to flow through port A, extending the cylinder. 414B senses the back pressure caused by the shifted valve, closes, and exhausts. Since the signal from valve #1 is blocked by the closed 414B, valve #2 (when actuated) shifts the control valve back. Air flows through port B, retracting the cylinder.

## Advanced Control Circuits

### Using Two Valves for Three-Position Function

Use these set-ups to obtain a Three-Position Function with (2) Two-Position valves. The circuitry shown is ideal for use with the Mead Isonic product line.

#### Pressure Applied Set-Up

De-activate Valve #1 for Retraction; Actuate Valve #2 for Extension.  
Supply pressure must be equal on both valve #1 and #2.

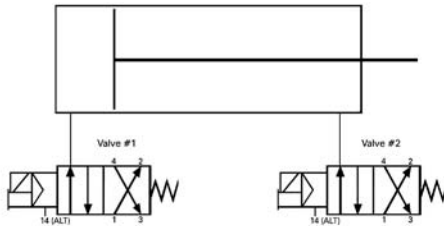

#### Pressure Relieved Set-Up

Actuate Valve #1 for Extension; Actuate Valve #2 for Retraction.  
Supply pressure does not have to be equal.

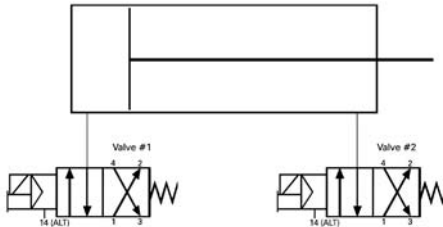

For an All-Ports-Blocked Three-Position Function, an additional two-way valve must be used for blocking the exhaust of the two valves. This third valve is actuated whenever either one of the other valves is actuated. Contact Mead to discuss further application set-ups.

## Two-Hand Extend One-Hand Retract

For applications where a secondary operation must occur, utilize this circuit. This circuit allows for the operator to be "tied down" during the clamping of a part via the actuation of the two-hand control. Once the rod movement has stopped, the operator can then move onto the secondary operation.

With the use of the stroke completion sensor the circuit will work even if clamping on material that is not consistently the same size.

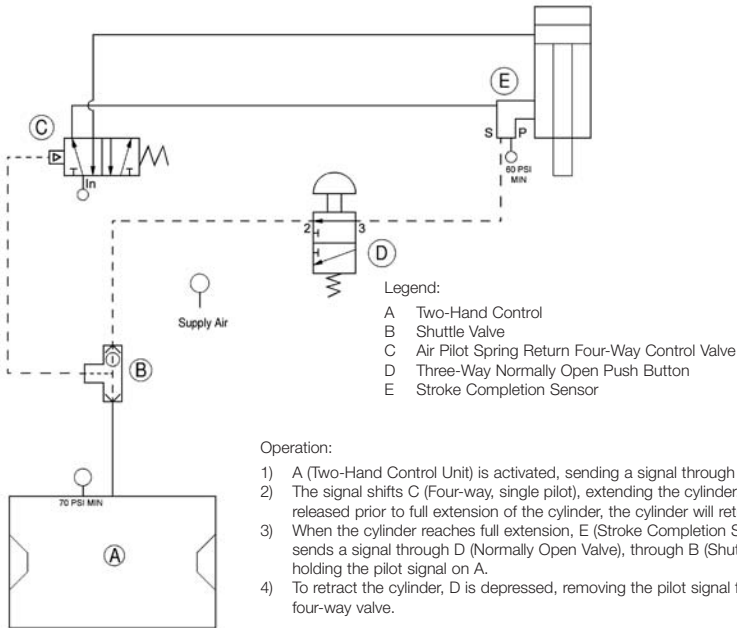

The Bill Of Materials below can be used to mix and match for your specific application. Multiple components may be added at "D".

(Example: Timer and Push Button combination for an automatic return or manual return.)

Item	Mead Part No.	Description
A	CSV-101	Two hand anti-tieddown control unit
	CSV-101 LS	Same as above, but with low stress buttons
	CSV-107 LS1	Same as CSV-101, but with remote buttons
	CSV-107 LS2	Same as above but with low force actuators
B	SV-1	Shuttle valve
C	N2-SP	1/4" port spring return
	C2-3	1/4" port spring return, rugged applications
	C5-3	1/2" port spring return, rugged applications
D	MV-140	Spring return three-way valve
	MV-ES	Emergency stop
	KLH-105	Timer 1-10 sec.
	MV-	Any MV- type valve will work here, set-up Normally Open
E	SCS-112	1/8" Stroke Completion Sensor (SCS)
	SCS-250	1/4" SCS
	SCS-375	3/8" SCS
	SCS-500	1/2" SCS

## Two-Hand Extend Two-Hand Retract

Use this circuit where a “pinch point” exists on both the extension and retraction of the linear actuator. This circuit will require the operator to use the two-hand control for either motion.

The suggested components will accommodate up to one 4” bore cylinder with relatively moderate speed. If a larger bore cylinder is used or more air volume is required, contact Mead.

Operation:

- 1) Operator sets “B” valve to either extend or retract cylinder.
- 2) Operator uses “A” (two-hand control) to move cylinder.
- 3) If one or both buttons are not actuated, cylinder will stop in place.

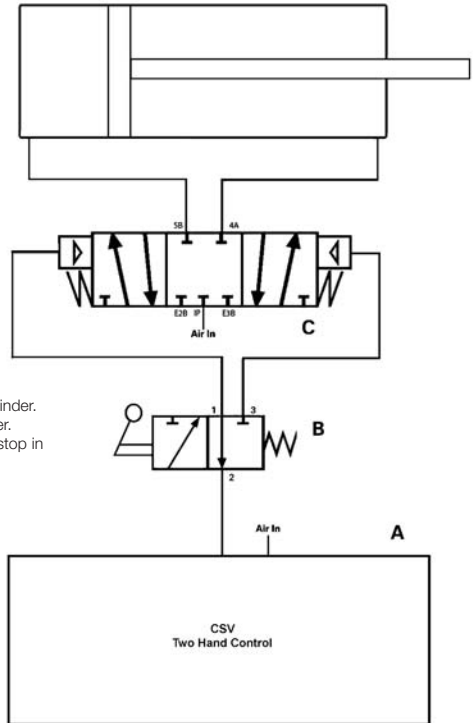

Item	Mead Part No.	Description
A	CSV-101	Two-hand anti-tiedown control unit
	CSV-101 LS	Same as above, but with low stress buttons
	CSV-107 LS1	Same as CSV-101, but with remote buttons
	CSV-107 LS2	Same as above but with low force actuators
B	MV-35	Two-position, detented, three-way valve
	MV-TP	Two-position, detented, three-way valve
C	C2-2H	Three-position, spring centered, four-way valve

## Two-Hand Extend with Automatic Return

This circuit is useful for applications where cycle time and safety is an issue. With the Automatic Return feature, the operator's hands are tied down and the cylinder will return when the work is completed, not when the operator removes their hands from the actuator.

Operator uses Mead CSV-102 (Two-Hand Control) to extend the cylinder. If one or both hands are removed, the cylinder returns. If the limit is reached, the cylinder will auto return even if the operator's hands remain on the two-hand control.

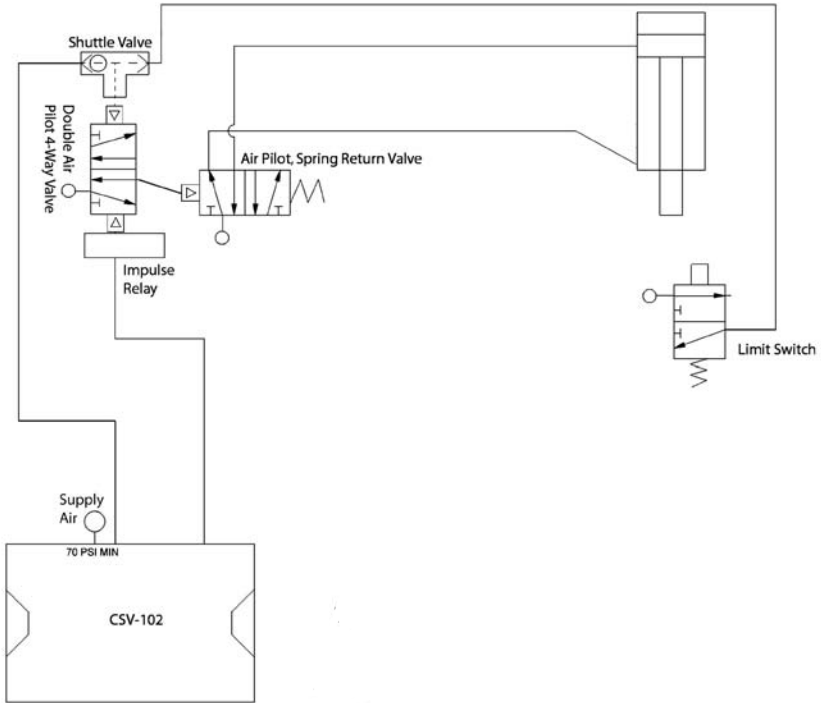

When actuated, CSV-102 pilots the Double Air Pilot Four-Way Valve to allow air to the Air Pilot Spring Return Valve. When released, the CSV-102 pilots the Double Air Pilot Four-Way Valve back to the original position. The Impulse Relay takes the constant input from the CSV-102 and changes it to an impulse allowing for the auto-return from the Limit Switch.

Bill of Material with Typical Mead Components	
Component	Mead Part Number
CSV-102	CSV-102
Impulse Relay	414B
Double Air Pilot Four-Way Valve	N2-DP
Shuttle Valve	SV-1
Air Pilot, Spring Return Valve	N2-SP
Limit Switch	MV Type

The suggested components will accommodate up to a 4" Bore Cylinder. Contact Mead if your application requires a larger bore cylinder.

### Air Filtration, Regulation, and Lubrication

Compressed air must be clean, lubricated properly, free from moisture, and pressure must be kept consistent in order to preserve operation and performance of machinery and extend the life of pneumatic components. Filters, regulators, lubricators, and desiccant dryers should be the first consideration of any pneumatic system.



**Air filters** remove particulate contamination and liquids from airlines. Particulate filters use plastic or bronze elements. Filters may be rated from 5 microns, capable of removing very small particulates, up to 100 microns. Coalescing filters remove oil and vapor. The liquids fill bowls which may have manual or automatic drains. In order to maintain performance, bowls must be drained and filters must be replaced on regular maintenance intervals. Desiccant dryers remove moisture from airlines to a more complete extent than would be possible using only air filters. Desiccant material absorbs moisture from the compressed air, changes color, and swells. As with filters, the desiccant material loses its properties with use, so the dryer or the material inside must be replaced on a regular maintenance schedule. The maintenance interval is entirely dependent on the application.



**Lubricators** add oil to the airlines. Atomizing lubricators are preferable (to drip type) because the atomization allows oil to travel greater distances. Usually there is an adjustment knob and indicator so the air/oil output ratio can be adjusted and monitored.



**Regulators** allow air pressure to be adjusted and controlled. A knob controls a diaphragm to respond to flow demand and pressure changes.

## Pneumatic Pipe Size

The pipe sizes listed in the chart below are assuming a 100 psi pneumatic system to carry air at a 1 psi loss per 100 feet. Conservatively figure each pipe fitting to equal five feet of pipe. At pressures other than 100 psi, flow capacity will be inversely proportionate to pressure (calculated by Boyle's Law and based upon absolute PSIA pressure levels).

SCFM Flow	Length of Run - Feet									Compressor HP
	25	50	75	100	150	200	300	500	1000	
6	1/2	1/2	1/2	1/2	1/2	1/2	1/2	3/4	3/4	1
18	1/2	1/2	1/2	3/4	3/4	3/4	3/4	1	1	3
30	3/4	3/4	3/4	3/4	1	1	1	1-1/4	1-1/4	5
45	3/4	3/4	1	1	1	1	1-1/4	1-1/4	1-1/4	7-1/2
60	3/4	1	1	1	1-1/4	1-1/4	1-1/4	1-1/2	1-1/2	10
90	1	1	1-1/4	1-1/4	1-1/4	1-1/4	1-1/2	1-1/2	2	15
120	1	1-1/4	1-1/4	1-1/4	1-1/2	1-1/2	1-1/2	2	2	20
150	1-1/4	1-1/4	1-1/4	1-1/2	1-1/2	2	2	2	2-1/2	25
180	1-1/4	1-1/2	1-1/2	1-1/2	2	2	2	2-1/2	2-1/2	30
240	1-1/4	1-1/2	1-1/2	2	2	2	2-1/2	2-1/2	3	40
300	1-1/2	2	2	2	2	2-1/2	2-1/2	3	3	50
360	1-1/2	2	2	2	2-1/2	2-1/2	2-1/2	3	3	60
450	2	2	2	2-1/2	2-1/2	3	3	3	3-1/2	75
600	2	2-1/2	2-1/2	2-1/2	3	3	3	3-1/2	4	100
750	2	2-1/2	2-1/2	3	3	3	3-1/2	3-1/2	4	125

## Pneumatic Pressure Loss

Figures in the table below are approximate psi compressed air pressure losses for every 100 feet of clean commercial steel pipe. (Schedule 40)

CFM Free Air	1/2"		3/4"		1"		1-1/4"		1-1/2"	
	80 psi	125 psi	80 psi	125 psi	80 psi	125 psi	80 psi	125 psi	80 psi	125 psi
10	0.45	0.30	0.11	0.08	0.04	0.02				
20	1.75	1.15	0.40	0.28	0.15	0.08				
30	3.85	2.55	0.90	0.60	0.30	0.20				
40	6.95	4.55	1.55	1.05	0.45	0.30				
50	10.50	7.00	2.40	1.60	0.75	0.50	0.18	0.12		
60			3.45	2.35	1.00	0.70	0.25	0.17		
70			4.75	3.15	1.35	0.90	0.35	0.23	0.16	0.10
80			6.15	4.10	1.75	1.20	0.45	0.30	0.20	0.14
90			7.75	5.15	2.25	1.50	0.56	0.40	0.25	0.17
100			9.60	6.35	2.70	1.80	0.65	0.45	0.30	0.20
125			15.50	9.80	4.20	2.80	1.05	0.70	0.45	0.32
150			23.00	14.50	5.75	4.00	1.45	1.00	0.65	0.45
175					8.10	5.45	2.00	1.30	0.90	0.60
200					10.90	7.10	2.60	1.75	1.15	0.80
250							4.05	2.65	1.80	1.20
300							5.80	3.85	2.55	1.70
350							7.90	5.15	3.55	2.35
400							10.30	6.75	4.55	3.05
450									5.80	3.80
500									7.10	4.70

## Air Flow Loss Through Pipes

Instructions: Find the factor from the chart below according to the pipe size and SCFM. Divide the factor by the Compression Ratio. Then multiply the number by the actual length of pipe, in feet, then divide by 1000. This result is the pressure loss in psi.

$$\text{Compression Ratio} = (\text{Gauge Pressure} + 14.7) / 14.7$$

$$\text{Pressure Loss (psi)} = \text{Factor} / \text{Compression Ratio} \times \text{Length of Pipe (Ft)} / 1000$$

**Factor Table**

SCFM	Pipe Size NPT							
	1/2"	3/4"	1"	1-1/4"	1-1/2"	1-3/4"	2"	2-1/2"
5	12.7	1.2	0.5					
10	50.7	7.8	2.2	0.5				
15	114	17.6	4.9	1.1				
20	202	30.4	8.7	2.0				
25	316	50.0	13.6	3.2	1.4	0.7		
30	456	70.4	19.6	4.5	2.0	1.1		
35	621	95.9	26.6	6.2	2.7	1.4		
40	811	125	34.8	8.1	3.6	1.9		
45		159	44.0	10.2	4.5	2.4	1.2	
50		196	54.4	12.6	5.6	2.9	1.5	
60		282	78.3	18.2	8.0	4.2	2.2	
70		385	106	24.7	10.9	5.7	2.9	1.1
80		503	139	32.3	14.3	7.5	3.8	1.5
90		646	176	40.9	18.1	9.5	4.8	1.9
100		785	217	50.5	22.3	11.7	6.0	2.3
110		950	263	61.1	27.0	14.1	7.2	2.8
120			318	72.7	32.2	16.8	8.6	3.3
130			369	85.3	37.8	19.7	10.1	3.9
140			426	98.9	43.8	22.9	11.7	4.4
150			490	113	50.3	26.3	13.4	5.2
160			570	129	57.2	29.9	15.3	5.9
170			628	146	64.6	33.7	17.6	6.7
180			705	163	72.6	37.9	19.4	7.5
190			785	177	80.7	42.2	21.5	8.4
200			870	202	89.4	46.7	23.9	9.3
220				244	108	56.5	28.9	11.3
240				291	128	67.3	34.4	13.4
260				341	151	79.0	40.3	15.7
280				395	175	91.6	46.8	18.2
300				454	201	105	53.7	20.9



## Pressure Loss Through Pipe Fittings

This chart gives figures that are the air pressure flow losses through screw fittings expressed in the equivalent lengths of straight pipe of the same diameter. For example, a 2" gate valve flow resistance would be the same as 1.3 feet of straight pipe.

Pipe Size NPT	Gate Valve	Long Radius Elbow*	Medium Radius Elbow**	Standard Elbow***	Angle Valve	Close Return Bend	Tee Thru Slide	Globe Valve
1/2"	0.31	0.41	0.52	0.84	1.1	1.3	1.7	2.5
3/4"	0.44	0.57	0.73	1.2	1.6	1.8	2.3	3.5
1"	0.57	0.77	0.98	1.6	2.1	2.3	3.1	4.7
1-1/4"	0.82	1.1	1.4	2.2	2.9	3.3	4.4	6.5
1-1/2"	0.98	1.3	1.6	2.6	3.5	3.9	5.2	7.8
2"	1.3	1.7	2.2	3.6	4.8	5.3	7.1	10.6
2-1/2"	1.6	2.2	2.8	4.4	5.9	6.6	8.7	13.1
3"	2.1	3.0	3.6	5.7	7.7	8.5	11.4	17.1
4"	3.0	3.9	5.0	7.9	10.7	11.8	15.8	23.7
5"	3.9	5.1	6.5	10.4	13.9	15.5	20.7	31.0

\* or run of standard tee

\*\* or run of tee reduced in size by 25%

\*\*\* or run of tee reduced in size by 50%

## Friction of Air in Hose

Pressure Drop per 25 feet of hose. Factors are proportionate for longer or shorter lengths.

Size	SCFM	50 psi	60 psi	70 psi	80 psi	90 psi	100 psi	110 psi
1/2" ID	20	1.8	1.3	1.0	0.9	0.8	0.7	0.6
	30	5.0	4.0	3.4	2.8	2.4	2.3	2.0
	40	10.1	8.4	7.0	6.0	5.4	4.8	4.3
	50	18.1	14.8	12.4	10.8	9.5	8.4	7.6
	60		23.4	20.0	17.4	14.8	13.3	12.0
	70			28.4	25.2	22.0	19.3	17.6
	80				34.6	30.5	27.2	24.6
3/4" ID	20	0.4	0.3	0.2	0.2	0.2	0.2	0.1
	30	0.8	0.6	0.5	0.5	0.4	0.4	0.3
	40	1.5	1.2	0.9	0.8	0.7	0.6	0.5
	50	2.4	1.9	1.5	1.3	1.1	1.0	0.9
	60	3.5	2.8	2.3	1.9	1.6	1.4	1.3
	70	4.4	3.8	3.2	2.8	2.3	2.0	1.8
	80	6.5	5.2	4.2	3.6	3.1	2.7	2.4
	90	8.5	6.8	5.5	4.7	4.0	3.5	3.1
	100	11.4	8.6	7.0	5.8	5.0	4.4	3.9
	110	14.2	11.2	8.8	7.2	6.2	5.4	4.9
1" ID	30	0.2	0.2	0.1	0.1	0.1	0.1	0.1
	40	0.3	0.3	0.2	0.2	0.2	0.2	0.2
	50	0.5	0.4	0.4	0.3	0.3	0.2	0.2
	60	0.8	0.6	0.5	0.5	0.4	0.4	0.3
	70	1.1	0.8	0.7	0.7	0.6	0.5	0.4
	80	1.5	1.2	1.0	0.8	0.7	0.6	0.5
	90	2.0	1.0	1.3	1.1	0.9	0.8	0.7
	100	2.6	2.0	1.6	1.4	1.2	1.0	0.9
	110	3.5	2.6	2.0	1.7	1.4	1.2	1.1

## Vacuum Flow Through Orifices

The chart below approximates flow that would be expected through a practical orifice. Flows are 2/3 of theoretical value obtained through a sharp edged orifice.

Chart Values are Air Flows in SCFM

Orifice Diameter, Inches	Degree of Vacuum Across Orifice, Inches of Mercury (Hg)								
	2"	4"	6"	8"	10"	12"	14"	18"	24"
1/64	0.018	0.026	0.032	0.037	0.041	0.045	0.048	0.055	0.063
1/32	0.074	0.100	0.128	0.148	0.165	0.180	0.195	0.220	0.250
1/16	0.300	0.420	0.517	0.595	0.660	0.725	0.780	0.880	1.00
1/8	1.2	1.68	2.06	2.37	2.64	2.89	3.12	3.53	4.04
1/4	4.8	6.7	8.3	9.5	10.6	11.6	12.4	14.0	16.2
3/8	10.8	15.2	18.5	21.4	23.8	26.0	28.0	31.8	36.4
1/2	19.1	27.0	33.0	38.5	42.3	46.3	50.0	56.5	64.6
5/8	30.0	42.2	51.7	59.5	66.2	72.6	78.0	88.0	101
3/4	43.0	60.6	74	85.3	95.2	104	112	127	145
7/8	58.8	82.6	101	116	130	142	153	173	198
1	76.5	108	131	152	169	185	200	225	258

**Decimal Equivalents**  
(of Fraction, Wire Gauge and Metric Sizes)

Sizes	Decimal Inches	Sizes	Decimal Inches	Sizes	Decimal Inches	Sizes	Decimal Inches
107	0.0019	.7mm	0.0276	1.95mm	0.0768	3.7mm	0.1457
106	0.0023	70	0.0280	5/64	0.0781	26	0.1470
105	0.0027	69	0.0292	47	0.0785	3.75mm	0.1476
104	0.0031	.75mm	0.0295	2mm	0.0787	25	0.1495
103	0.0035	68	0.0310	2.05mm	0.0807	3.8mm	0.1496
102	0.0039	1/32	0.0312	46	0.0810	24	0.1520
101	0.0043	.8mm	0.0315	45	0.0820	3.9mm	0.1535
100	0.0047	67	0.0320	2.1mm	0.0827	23	0.1540
99	0.0051	66	0.0330	2.15mm	0.0846	5/32	0.1562
98	0.0055	.85mm	0.0335	44	0.0860	22	0.1570
97	0.0059	65	0.0350	2.2mm	0.0866	4mm	0.1575
96	0.0063	.9mm	0.0354	2.25mm	0.0886	21	0.1590
95	0.0067	64	0.0360	43	0.0890	20	0.1610
94	0.0071	63	0.0370	2.3mm	0.0906	4.1mm	0.1614
93	0.0075	.95mm	0.0374	2.35mm	0.0925	4.2mm	0.1654
92	0.0079	62	0.0380	42	0.0935	19	0.1660
.2mm	0.0079	61	0.0390	3/32	0.0938	4.25mm	0.1673
91	0.0083	1mm	0.0394	2.4mm	0.0945	4.3mm	0.1693
90	0.0087	60	0.0400	41	0.0960	18	0.1695
.22mm	0.0087	59	0.0410	2.45mm	0.0965	11/64	0.1719
89	0.0091	1.05	0.0413	40	0.0980	17	0.1730
88	0.0095	58	0.0420	2.5mm	0.0984	4.4mm	0.1732
25mm	0.0098	57	0.0430	39	0.0995	16	0.1770
87	0.0100	1.1mm	0.0433	38	0.1015	4.5mm	0.1772
86	0.0105	1.15mm	0.0453	2.6mm	0.1024	15	0.1800
85	0.0110	56	0.0465	37	0.1040	4.6mm	0.1811
.28mm	0.0110	3/64	0.0469	2.7mm	0.1063	14	0.1820
84	0.0115	1.2mm	0.0472	36	0.1065	13	0.1850
.3mm	0.0118	1.25mm	0.0492	2.75mm	0.1083	4.7mm	0.1850
83	0.0120	1.3mm	0.0512	7/64	0.1094	4.75mm	0.1870
82	0.0125	55	0.0520	35	0.1100	3/16	0.1875
.32mm	0.0126	1.35mm	0.0531	2.8mm	0.1102	4.8mm	0.1890
81	0.0130	54	0.0550	34	0.1110	12	0.1890
80	0.0135	1.4mm	0.0551	33	0.1130	11	0.1910
.35mm	0.0138	1.45mm	0.0571	2.9mm	0.1142	4.9mm	0.1929
79	0.0145	1.5mm	0.0591	32	0.1160	10	0.1935
1/64	0.0156	53	0.0595	3mm	0.1181	9	0.1960
.4mm	0.0157	1.55mm	0.0610	31	0.1200	5mm	0.1969
78	0.0160	1/16	0.0625	3.1mm	0.1220	8	0.1990
.45mm	0.0177	1.6mm	0.0630	1/8	0.1250	5.1mm	0.2008
77	0.0180	52	0.0635	3.2mm	0.1260	7	0.2010
.5mm	0.0197	1.65mm	0.0650	3.25mm	0.1280	13/64	0.2031
76	0.0200	1.7mm	0.0669	30	0.1285	6	0.2040
75	0.0210	51	0.0670	3.3mm	0.1299	5.2mm	0.2047
.55mm	0.0217	1.75mm	0.0689	3.4mm	0.1339	5	0.2055
74	0.0225	50	0.0700	29	0.1360	5.25mm	0.2067
.6mm	0.0236	1.8mm	0.0709	3.5mm	0.1378	5.3mm	0.2087
73	0.0240	1.85mm	0.0728	28	0.1405	4	0.2090
72	0.0250	49	0.0730	9/64	0.1406	5.4mm	0.2126
.65mm	0.0256	1.9mm	0.0748	3.6mm	0.1417	3	0.2130
71	0.0260	48	0.0760	27	0.1440	5.5mm	0.2165

## Section VII: Conversions

### Decimal Equivalents (of Fraction, Wire Gauge and Metric Sizes)

Sizes	Decimal Inches	Sizes	Decimal Inches	Sizes	Decimal Inches	Sizes	Decimal Inches
7/32	0.2188	7.4mm	0.2913	V	0.3770	21/32	0.6562
5.6mm	0.2205	M	0.2950	9.6mm	0.3780	17mm	0.6693
2	0.2211	7.5mm	0.2953	9.7mm	0.3819	43/64	0.6719
5.7mm	0.2244	19/64	0.2969	9.75mm	0.3839	11/16	0.6875
5.75mm	0.2264	7.6mm	0.2992	9.8mm	0.3858	17.5mm	0.6890
1	0.2280	N	0.3020	W	0.3860	45/64	0.7031
5.8mm	0.2283	7.7mm	0.3031	9.9mm	0.3898	18mm	0.7087
5.9mm	0.2323	7.75mm	0.3051	25/64	0.3906	23/32	0.7188
A	0.2340	7.8mm	0.3071	10mm	0.3937	18.5mm	0.7283
15/64	0.2344	7.9mm	0.3110	X	0.3970	47/64	0.7344
6mm	0.2362	5/16	0.3125	Y	0.4040	19mm	0.7480
B	0.2380	8mm	0.3150	13/32	0.4062	3/4	0.7500
6.1mm	0.2402	O	0.3160	Z	0.4130	49/64	0.7656
C	0.2420	8.1mm	0.3189	10.5mm	0.4134	19.5mm	0.7677
6.2mm	0.2441	8.2mm	0.3228	27/64	0.4219	25/32	0.7812
D	0.2460	P	0.3230	11mm	0.4331	20mm	0.7874
6.25mm	0.2461	8.25mm	0.3248	7/16	0.4375	51/64	0.7969
6.3mm	0.2480	8.3mm	0.3268	11.5mm	0.4528	20.5mm	0.8071
E	0.2500	21/64	0.3281	29/64	0.4531	13/16	0.8125
1/4	0.2500	8.4mm	0.3307	15/32	0.4688	21mm	0.8268
6.4mm	0.2520	Q	0.3320	12mm	0.4724	53/64	0.8281
6.5mm	0.2559	8.5mm	0.3346	31/64	0.4844	27/32	0.8438
F	0.2570	8.6mm	0.3386	12.5mm	0.4921	21.5mm	0.8465
6.6mm	0.2598	R	0.3390	1/2	0.5000	55/64	0.8594
G	0.2610	8.7mm	0.3425	13mm	0.5118	22mm	0.8661
6.7mm	0.2638	11/32	0.3438	33/64	0.5156	7/8	0.8750
17/64	0.2656	8.75mm	0.3445	17/32	0.5312	22.5mm	0.8858
6.75mm	0.2657	8.8mm	0.3465	13.5mm	0.5315	57/64	0.8906
H	0.2660	S	0.3480	35/64	0.5469	23mm	0.9055
6.8mm	0.2677	8.9mm	0.3504	14mm	0.5512	29/32	0.9062
6.9mm	0.2717	9mm	0.3543	9/16	0.5625	59/64	0.9219
I	0.2720	T	0.3580	14.5mm	0.5709	23.5mm	0.9252
7mm	0.2756	9.1mm	0.3583	37/64	0.5781	15/16	0.9375
J	0.2770	23/64	0.3594	15mm	0.5906	24mm	0.9449
7.1mm	0.2795	9.2mm	0.3622	19/32	0.5938	61/64	0.9531
K	0.2810	9.25mm	0.3642	39/64	0.6094	24.5mm	0.9646
9/32	0.2812	9.3mm	0.3661	15.5mm	0.6102	31/32	0.9688
7.2mm	0.2835	U	0.3680	5/8	0.6250	25mm	0.9843
7.25mm	0.2854	9.4mm	0.3701	16mm	0.6299	63/64	0.9844
7.3mm	0.2874	9.5mm	0.3740	41/64	0.6406	1	1.000
L	0.2900	3/8	0.3750	16.5mm	0.6496		

## Conversions Between US Units (English) and SI Units (Metric)

Quantity	US Unit	SI Unit	Conversion Factor
Length	inch (in.)	millimeter (mm)	1 in. = 25.4mm
Pressure*	pounds/sq. in.	bar	1 bar = 14.5 psi
Vacuum**	inches of mercury (in. Hg)	mm of mercury (mm Hg)	1" Hg = 25.4mm Hg
Flow***	cubic feet per minute (cfm)	cubic decimeters per sec (dm <sup>3</sup> /sec)	2.12 cfm - 1 dm <sup>3</sup> /sec
Force	pound (f) or lb. (f)	Newton (N)	1 lb (f) = 4.44 N
Mass	pound (m) or lb. (m)	kilogram (Kg)	1 Kg = 2.2 lbs.
Volume****	gallon (US gallon)	liter (l)	1 US Gal = 3.71 l
Temperature	degrees Fahrenheit (°F)	degrees Celsius (°C)	°C = 5/9 (°F -32)
Torque	pounds (f) - inches (lbs (f) - in.)	Newton-meters (Nm)	1 Nm = 8.88 lb(f)-in.
Power	horsepower (HP)	kilowatt (kw)	1 kw = 1.34 HP
Frequency	cycles per second (cps)	Hertz (Hz)	1 Hz = 1 cps
Velocity	feet per second (fps)	meter per second (m/s)	1 m/s = 3.28 fps

\*Above Atmospheric (psi or Bar); \*\*Below Atmospheric (Hg); \*\*\*Gas; (f) = force; (m) = mass

### Interchange Tables

**How to Use:** The following charts interchange units from the SI International Standard, the US system (or English System) and older metric systems. The left column is the basic SI unit. Equivalents are in the same line. To best use these charts, find the unit that is to be converted and move to the row with the "1" in it. Move in the same row to the unit you are changing the value to and multiply by that number to make the conversion.

#### Torque

Newton-Meters	Kilopond-Meters	Foot-lbs	Inch-lbs
1	$1.020 \times 10^{-1}$	$7.376 \times 10^{-1}$	8.851
0.01	1	7.233	86.80
1.356	$1.382 \times 10^{-1}$	1	12
$1.130 \times 10^{-1}$	$1.52 \times 10^{-2}$	$8.333 \times 10^{-2}$	1

#### Gravity Due to Acceleration

US System (g) = 32.2 feet per sec. per sec.  
Metric System (g) = 9.8 meters per sec. per sec.

#### Length

(Linear Measurement)

Meter	Centimeter	Kilometer	Mile	Inch	Foot
1	100	$1 \times 10^4$	$6.214 \times 10^{-4}$	39.370	3.281
0.01	1	$1 \times 10^5$	$6.214 \times 10^{-6}$	$3.937 \times 10^{-1}$	$3.281 \times 10^{-2}$
$1 \times 10^{-3}$	0.10	$1 \times 10^{-6}$	$6.214 \times 10^{-7}$	$3.937 \times 10^{-2}$	$3.281 \times 10^{-3}$
$1 \times 10^3$	$1 \times 10^5$	1	$6.214 \times 10^{-7}$	$3.937 \times 10^4$	$3.281 \times 10^3$
$1.609 \times 10^3$	$1.609 \times 10^5$	1.609	1	$6.336 \times 10^4$	5280
$2.540 \times 10^{-2}$	2.540	$2.540 \times 10^{-5}$	$1.578 \times 10^{-5}$	1	$8.333 \times 10^{-2}$
$3.048 \times 10^{-1}$	30.479	$3.048 \times 10^{-4}$	$1.894 \times 10^{-4}$	12	1

1 mm = 0.001 m = 0.10 cm = 0.000001 km = 0.03937 in = 0.003281 ft

#### AREA

(Square Measurement)

Square Meter	Sq. Centimeter	Sq. Kilometer	Square Inch	Square Foot	Square Mile
1	$1 \times 10^4$	$1 \times 10^6$	$1.550 \times 10^3$	10.764	$3.861 \times 10^{-7}$
$1 \times 10^{-3}$	1	$1 \times 10^{-10}$	$1.550 \times 10^{-1}$	$1.076 \times 10^{-3}$	$3.861 \times 10^{-11}$
$1 \times 10^{-6}$	$1 \times 10^{-2}$	$1 \times 10^{-12}$	$1.550 \times 10^3$	$1.076 \times 10^{-5}$	$3.861 \times 10^{-13}$
$1 \times 10^6$	$1 \times 10^{10}$	1	$1.550 \times 10^9$	$1.076 \times 10^7$	$3.861 \times 10^{-1}$
$6.452 \times 10^{-4}$	6.452	$6.452 \times 10^{-10}$	1	$6.944 \times 10^{-3}$	$2.491 \times 10^{-10}$
$9.290 \times 10^{-2}$	$9.290 \times 10^2$	$9.290 \times 10^{-8}$	144	1	$3.587 \times 10^{-8}$
$2.590 \times 10^6$	$2.590 \times 10^{10}$	2.590	$2.788 \times 10^7$	$2.788 \times 10^7$	1

1 sq. mm = 0.000001 sq. m = 0.00155 sq. in. = 0.00001076 sq. ft

## Section VII: Conversions

### Volume (Cubic)

Cubic Meter	Cu. Decimeter	Cu. Centimeter	US Gallon	Cu. Inch	Cubic Foot
1	$1 \times 10^3$	$1 \times 10^6$	$2.642 \times 10^{-2}$	$6.102 \times 10^4$	35.314
$1 \times 10^{-3}$	1	$1 \times 10^3$	$2.642 \times 10^{-1}$	61.024	$3.531 \times 10^{-2}$
$1 \times 10^{-6}$	$1 \times 10^{-3}$	1	$2.642 \times 10^{-4}$	$6.102 \times 10^2$	$3.531 \times 10^{-5}$
$4.546 \times 10^{-3}$	4.546	$4.546 \times 10^3$	1.200	$2.774 \times 10^2$	$1.605 \times 10^{-1}$
$3.785 \times 10^{-3}$	3.785	$3.785 \times 10^3$	1	$2.310 \times 10^2$	$1.337 \times 10^{-1}$
$1.639 \times 10^{-5}$	$1.639 \times 10^{-2}$	16.387	$4.329 \times 10^{-3}$	1	$5.787 \times 10^{-4}$
$2.832 \times 10^{-2}$	28.317	$2.832 \times 10^4$	7.481	$1.728 \times 10^3$	1

1 imperial gallon = 1.2 US gallon = 0.004546 cu. meter = 4.546 liter = 4546 cu. centimeters

### Force (Including Force due to Weight)

Newton	Dyne	Kilopond	Metric Ton	US Ton	Pound
1	$1 \times 10^5$	$1.020 \times 10^{-1}$	$1.020 \times 10^{-4}$	$1.124 \times 10^{-4}$	$2.248 \times 10^{-1}$
$1 \times 10^5$	1	$1.020 \times 10^{-6}$	$1.020 \times 10^{-9}$	$1.124 \times 10^{-9}$	$2.248 \times 10^{-6}$
9.807		1	$1 \times 10^{-3}$	$1.102 \times 10^{-3}$	2.205
$9.807 \times 10^3$	$9.807 \times 10^8$	1000	1	1.102	$2.205 \times 10^3$
$9.964 \times 10^3$	$9.964 \times 10^8$	$1.016 \times 10^2$	1.016	1.120	$2.240 \times 10^3$
$8.896 \times 10^3$	$8.896 \times 10^8$	$9.072 \times 10^2$	$9.072 \times 10^{-1}$	1	2000
4.448	$4.448 \times 10^5$	$4.536 \times 10^{-1}$	$4.536 \times 10^{-4}$	$5 \times 10^{-4}$	1

1 long ton = 9964 Newtons = 1016 Kiloponds = 1.016 metric tons = 1.120 US tons = 2240 pounds

### Mass (Not Weight)

Kilogram	Gram	Metric Ton	Newton	Pound	US Ton
1	1000	$1 \times 10^{-3}$	9.807	2.205	$1.102 \times 10^{-3}$
$1 \times 10^{-3}$	1	$1 \times 10^{-6}$	$9.807 \times 10^{-3}$	$2.205 \times 10^{-3}$	$1.102 \times 10^6$
$1 \times 10^3$	$1 \times 10^6$	1	$9.807 \times 10^3$	$2.205 \times 10^3$	1.102
$1.020 \times 10^{-1}$	$1.020 \times 10^2$	$1.020 \times 10^{-4}$	1	$2.248 \times 10^{-1}$	$1.120 \times 10^{-4}$
$4.536 \times 10^{-1}$	$4.536 \times 10^2$	$4.536 \times 10^{-4}$	4.448	1	$5 \times 10^{-4}$
14.594	$1.459 \times 10^4$	$1.459 \times 10^{-2}$	$1.431 \times 10^{-2}$	32.170	$1.609 \times 10^{-2}$
$9.072 \times 10^2$	$9.072 \times 10^5$	$9.072 \times 10^{-1}$	$8.896 \times 10^3$	2000	1

### Unit Pressure (Either Fluid or Mechanical)

Bar	Newton/m <sup>2</sup> (Pascal)	Kilopond/m <sup>2</sup>	Atmosphere	Pounds/Ft <sup>2</sup>	Pounds/Inch <sup>2</sup> (psi)
$1 \times 10^{-5}$	1	$1.020 \times 10^{-1}$	$9.869 \times 10^6$	$2.088 \times 10^{-2}$	$1.45 \times 10^{-4}$
1	$1 \times 10^6$	$1.020 \times 10^4$	$9.869 \times 10^{-1}$	$2.088 \times 10^3$	14.5
$9.807 \times 10^{-5}$	9.807	1	$9.678 \times 10^{-5}$	$2.048 \times 10^{-1}$	$1.422 \times 10^{-3}$
$9.807 \times 10^{-1}$	$9.807 \times 10^4$	$1 \times 10^4$	$9.678 \times 10^{-1}$	$2.048 \times 10^3$	14.220
1.013	$1.013 \times 10^5$	$1.033 \times 10^4$	1	$2.116 \times 10^3$	14.693
$4.789 \times 10^{-4}$	47.893	4.884	$4.726 \times 10^{-4}$	1	$6.944 \times 10^{-3}$
$6.897 \times 10^{-2}$	$6.897 \times 10^3$	$7.033 \times 10^2$	$6.806 \times 10^{-2}$	$1.440 \times 10^2$	1

1 kiloponds/sq. cm. = 0.9807 bar = 98070 Pascal = 0.9678 atmos = 2048 lbs/sq. ft. = 14.22 lbs/sq. in.

### Velocity

Meters/Second	Kilometers/Hour	Miles/Hour	Feet/Minute	Feet/Second	Inches/Minute
1	3.6	2.237	$1.968 \times 10^2$	3.281	$2.362 \times 10^3$
$1 \times 10^{-1}$	$1 \times 10^{-4}$	$6.214 \times 10^{-5}$	$5.468 \times 10^{-3}$	$9.113 \times 10^{-5}$	$6.562 \times 10^{-2}$
$2.778 \times 10^{-1}$	1	$6.214 \times 10^{-1}$	$5.468 \times 10^{-1}$	$9.113 \times 10^{-1}$	$6.562 \times 10^2$
$4.470 \times 10^{-1}$	1.609	1	88	1.467	$1.056 \times 10^3$
$5.080 \times 10^{-3}$	$1.829 \times 10^{-2}$	$1.136 \times 10^{-2}$	1	$1.667 \times 10^{-2}$	12
$3.048 \times 10^{-1}$	1.097	$6.818 \times 10^{-1}$	60	1	$7.2 \times 10^2$
$4.233 \times 10^{-4}$	$1.524 \times 10^{-3}$	$9.470 \times 10^{-4}$	$8.333 \times 10^{-2}$	$1.389 \times 10^{-3}$	1

1 decimeter/second = 0.1 meters/second = 0.005468 feet/minute = 0.06562 inches/minute











Your stocking distributor is:



**Bimba Manufacturing Company**

P.O. Box 68  
Monee, Illinois 60449-0068  
Phone: 708-534-8544  
Toll Free: 800-44-BIMBA  
Fax: 708-235-2014  
Email: [support@bimba.com](mailto:support@bimba.com)  
[www.bimba.com](http://www.bimba.com)



Worldwide distribution means there is a professional stocking Bimba distributor nearby ready to service your needs.