



- » Supports IEC61131-3 programming
- » LD, FBD, ST, SFC, IL languages
- » 0.02µs per contact

FL050-V2

Salient Features

- DIN rail / Back panel mounted slim PLC
- Up-to 2 Serial Ports. Support for various PLC protocols
- One Ethernet port to connect PLC / Programming Port / Remote Monitoring over modbus TCP/IP
- 1 USB Device Port
- Expandable up-to 8 expansions
- 32 Bit RISC processor
- Built-in RTC
- One micro SD card slot for upload, download of program
- DC powered units (24 V DC)
- Simple Ladder programming using Windows® based software
- Support for LD, FBD, ST, SFC, IL type IEC61131-3 programming languages
- Support for web server functionality
- CE, UL Class1 Div2 approved

Model Description

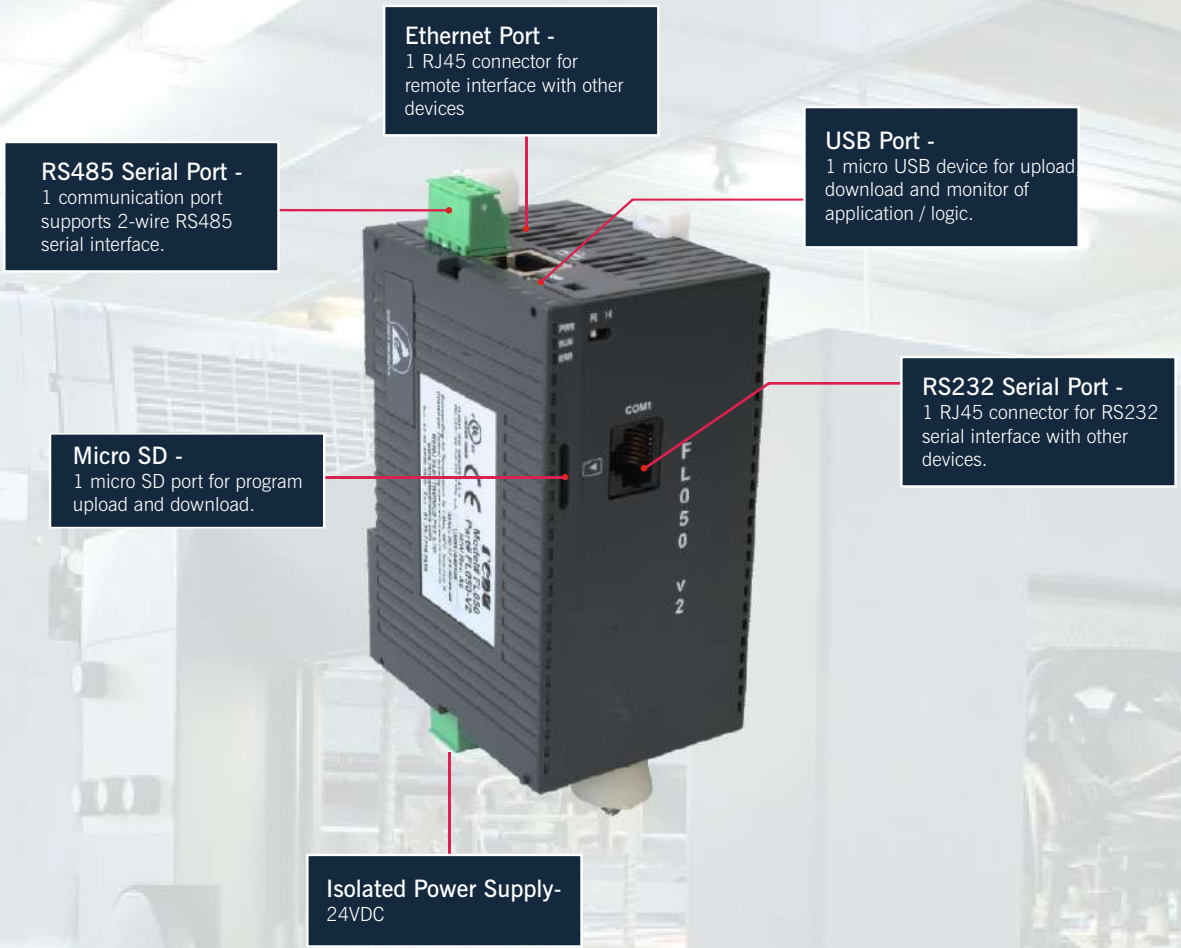

PLC Based Control Application

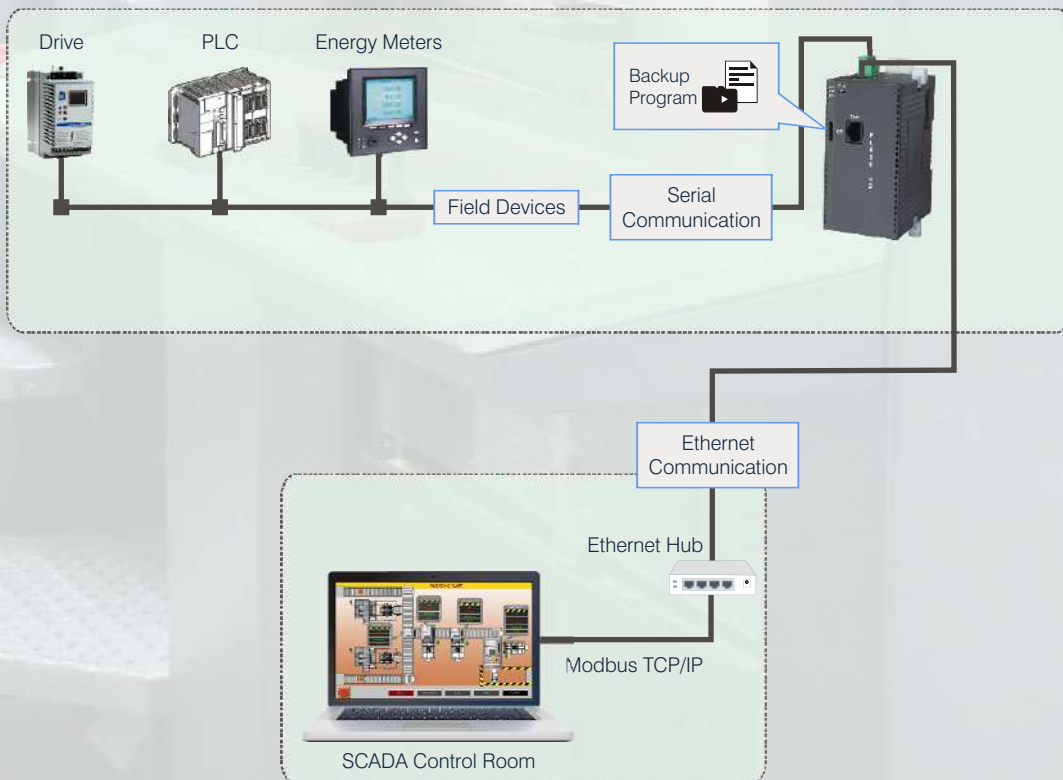

Software Features

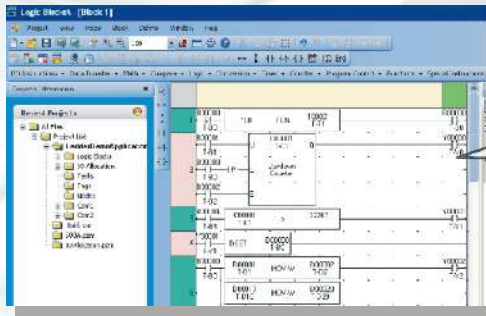

Configuration Software
FlexiSoft® is a compact, Windows® based software to configure the PLC. This image from FlexiSoft® shows the snap shot of ladder configuration window.

IEC61131-3 Programming Environment
Create application using LD language

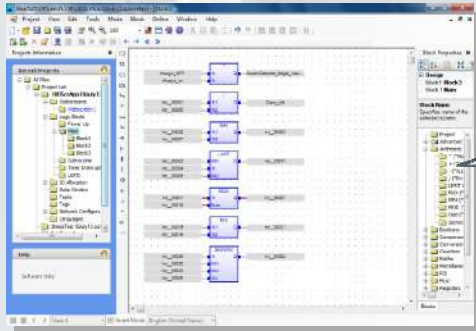
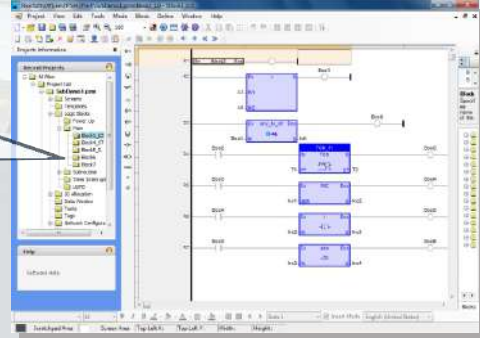

IEC61131-3 Programming Environment
Create application using FBD language

IEC61131-3 Programming Environment
Create application using IL language

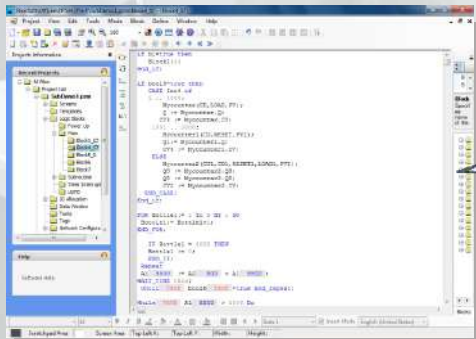
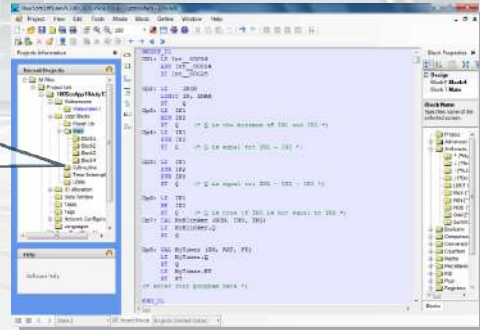

IEC61131-3 Programming Environment
Create application using ST language

Web Server functionality
FlexiSoft® now supports powerful and user friendly Web server functionality. It allows user to monitor and control from remote locations.

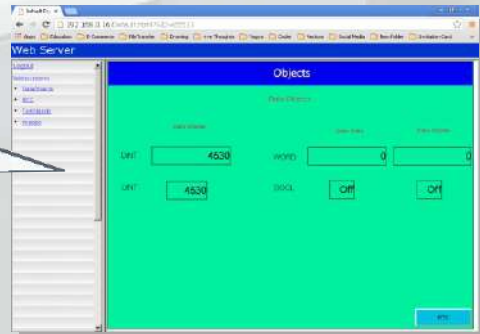

- System requirements for FlexiSoft® Software are -
- Windows Version : Microsoft Windows® 2000 or above
 - Processor : 800 MHz PENTIUM or higher
 - RAM : 256 MB or more
 - Hard Disk Space : 1 GB
 - Display resolution : 1024 x 768 High Color (16-bit)
 - Serial Port : 1 serial port for FlexiPanels® programming
 - USB Port : 1 USB port (Host) for FlexiPanels® programming
 - Keyboard : Required
 - Mouse : Required

Software Features

Web Server : FLO50-V2 supports web server functionality. It can be used to monitor and control from remote locations.

Following are the features of the web server:

i) User can create up to 100 Web screens in a project.

ii) Up-to 10 users can make active connection with web server at any instance.

V) Supports Data Entry, Data Display, Images, Multilingual text and Navigation buttons.

ii) User can use up to 100 tags in a Web screen.

iv) Fast data refresh (1 sec)

Comprehensive Instructions supported in FlexiLogics® : Native Ladder Instructions -

Some of the supported Instructions in FlexiLogics® are listed below :

1. Math

Instructions such as ADD, Subtract, Multiply and Divide. These instructions could be Single word or Double word, signed or unsigned format.

2. Data compare

Instructions such as Less than, Greater than, Equal to, Less than or Equal to, Greater than or Equal to etc. are supported.

3. Data Transfer Instructions

Data transfer instruction supports word and double word operands, Multiplexer / demultiplexer instructions.

4. Data conversion

Data conversion such as hex to ASCII, ASCII to hex, Binary, BCD, 2's Compliment, 7 segment etc. are possible.

5. Shift / Rotate

Rotate left, Rotate Right, Shift Left, Shift Right for word / double word.

6. I/O Instructions

Normally Open / Normally Closed contacts, positive pulse contact, negative pulse contact, Leading / Falling edge etc. are implemented.

7. Immediate I/O instruction

This instruction can be used to sample instantaneous physical inputs and outputs in PLC ladder.

8. Set / Reset Coil / Bit / Register Set / Reset Instructions are supported.

9. Program Control FlexiLogics® also support subroutine call, MCS / MCR, JCS / JCR, Enable / Disable Interrupts and step sequence instructions.

10. Functions

The function instructions like Moving average, Digital filter, Function generator, PID , Encode / Decode, Min / Max / Average Value, Lower / Upper Limit, Flip Flop are also supported.

Some of the supported IEC 61131-3 instructions are listed below:

1. Advanced-

Instructions such as Alarm_A, Alarm_M, Average, Derivate, Hyster ,RAMP etc .are supported.

2. Arithmetic-

Instructions such as Multiply ,Divide, Addition Substraction, MOD etc .are supported.

3. Booleans- Boolean And, F_TRIG, OR, FlipFlop, R_TRIG, XOR etc .are supported.

4. Comparisons-

Less than ,Less or equal, Is not equal ,Greater than etc. are supported.

5. Conversions-

Conversions such as Any to bool, Any to dint, Any to int ,Any to real etc. are possible.

6. Counters-

CTD(Down Counter) ,CTU(UP Counter), TUD(Up-Down Counter), CTDr(Down counter with rising edge detection), CTUDr(UP/DOWN counter With rising edge detection) are supported.

7. Maths-

Abs, modR , root trunc.

8. Miscellaneous-

ActiveRTSwitch, EnableEvents are supported instructions.

9. PID-

PID instruction is supported.

10. Registers-

And_mask, Habyte, Hiword, Lobby etc.

11. Selectors-

MUX, SEL, MUX4, MUX8.

12. Standard-

Instructions such as 1, DEC, INC, Neg etc are supported.

13. Timers-

Blink, PLS, TMD, TMU, TOF, TON etc. instructions are supported

14. Strings-

Instructions such as ASCII, CONCAT, AtoH, Char, Mlen etc. are supported.

General Specifications

Functional	
Program Capacity	5120K Steps
Total Program Memory	75MB (45 MB Application + 30MB Ladder)
Execution Speed	20.43 ns / contact
	81.72 ns/coil
	127.12 ns/16 bit transfer
	124.85 ns/16 bit signed addition
Clock-Calendar	Year, month, day, hour, minute, second, & Day of the week

Environmental	
Temperature	0 to 60° C (operating), -20 to 85° C (storage)
Humidity	10 to 90 % non condensing
Vibration immunity	IEC60068-2-6
Shock immunity	IEC60068-2-27
Dimensions (mm)	100mm(H) X 26mm(W) X 70mm(D)
Weight (Approx.)	150 gms.
Isolation	Isolation between communication ports, power and I/O is 500 V DC for 1 Min.

EMI/EMC	
Immunity to ESD	as per IEC61000-4-2
Immunity to Fast Transients	as per IEC61000-4-4
Immunity to Radiated electromagnetic field	as per IEC61000-4-3
Immunity to Conducted disturbances	as per IEC61000-4-6
Surge	as per IEC61000-4-5
Radiated emission	as per EN55011

Hardware Specifications		
Processor	32 bit RISC Processor	
Power Supply	Input Voltage	24VDC
	Tolerance	-15% and +20%
	Reverse polarity protection	YES
Communication ports	2 Serial ports	COM1 : RS232/ RS422/RS485 2 and 4 wire. RJ45 Connector COM2 : 2 Wire RS485. 4 pin PBT connector
	1 Ethernet port	10/100 Mbps
	1 USB device port	For Upload, Download and monitoring
	1 Expansion connection slot	8 expansion modules / 64 I/O points
SD card slot	1 Micro SD card slot	
Switches	PLC mode Control Switch	RUN/HALT
Memory	User Application	45MB
	Ladder	30MB
	Retentive (EEPROM based with limited write cycles)	1400 words
	Keep memory area (Data retained at power down)	1000 words
RTC	Built-in RTC	
Approvals	CE, UL (Class 1 Div 2), RoHS	

Functional Specifications			
Communication	2 serial ports	COM1 : RS232/ RS422/RS485 2 and 4 wire.	Upload, Download, Monitoring, Serial communication
		COM2 : 2 Wire RS485	2 Wire RS485 Communication
	1 Ethernet	10/100 Mbps	Upload, Download, Monitoring, Ethernet communication
	1 USB Device	USB 2.0 Device port	Upload, Download and Monitoring
	Expansion	Backplane bus	8 Slots (All FL Expansions)
SD Card Slot	Micro SD Card Slot	Multinode	Serial
		Type	microSD HC
		Capacity	High Capacity (4GB to 32GB)
		Speed Class	U4 U10
		UHS Speed Class	U1

Protocols Supported for

Driver	FL050-V2
ABB PLCs	✓
Allen Bradley DF1	✓
Aromat FP Series	✓
Baldor	✓
Danfoss Drive	✓
Delta PLCs	✓
FlexiLogics Slave Driver	✓
GE SNP	✓
GE SNP- X	✓
Idec PLCs	✓
LG Master K Series PLC	✓
LG Master K 300S	✓
Mitsubishi FX	✓

Driver	FL050-V2
Mitsubishi Q Series PLCs (Serial)	✓
Modbus ASCII (Unit as Master)	✓
Modbus RTU (Unit as Master)	✓
Modbus RTU (Unit as Slave)	✓
Serial monitor	✓
Serial Printer	✓
Toshiba (Link Port) Series PLCs	✓
Toshiba Inverters PLCs	✓
Toshiba T Series	✓
TriPLC	✓
Twido PLCs	✓
Unitelway PLCs	✓
Universal Serial Driver(ASCII)	✓

Expansion Models

Digital Expansion Modules

Model	Digital I/P	Digital O/P	Digital O/P
FLD1600	16	0	16 Digital Inputs
FLD0016P	0	16	16 Digital Outputs (PNP)
FLD0016N	0	16	16 Digital Outputs (NPN)
FLD0016R	0	16	16 Digital Outputs (Relay)
FLD0808P	8	8	8 Digital Inputs, 8 PNP type Transistor Outputs Digital module
FLD0808N	8	8	8 Digital Inputs, 8 NPN type Transistor Outputs Digital module
FLD0808R	8	8	8 Digital Inputs, 8 Relay type Outputs Digital module
FLD-HS-0808P	8	8	8 Digital Inputs, 8 Digital Outputs (PNP), 4 High Speed Inputs (Single phase & Quadrature counter), 2 PWM Outputs
FLD-HS-0808N	8	8	8 Digital Inputs, 8 Digital Outputs (NPN), 4 High Speed Inputs (Single phase & Quadrature counter), 2 PWM Outputs

Analog Expansion Modules

Model	Analog I/P	Analog O/P	Digital O/P
FLA0800L	8	0	8 Analog Inputs (0-10 VDC / 4-20 mA), 16 Bits
FLA0402U	4	2	4 Universal Inputs (0-10 V / 0-100 mV / 0-50 mV / 0-20 mA / 4-20 mA / RTD PT-100 / Thermocouple - B, R, S, E, J, K, N, T) 2 Analog Outputs (0-10 V / 4-20mA), 16 Bits
FLA0004	0	4	4 Analog Outputs (0-10 VDC / 4-20 mA), 16 Bits

N: Transistor output (NPN 500mA), R: Relay O/P. (6 Relay + 2 OC) P: PNP output (500mA)

Dimensions

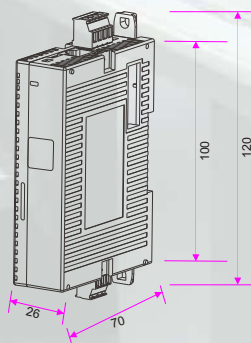

Fig. A
FlexiLogics®
controller module

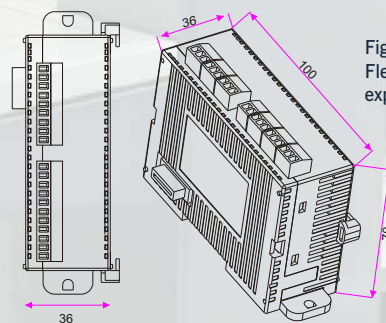

Fig B
FlexiLogics®
expansion module

All dimensions are in mm.

Please contact factory for more information. We welcome an opportunity to develop new, custom drivers and customized units.



HEAD OFFICE

Survey No. 2/6, Baner Road, Pune - 411045, India.
Tel : +91 20 2729 2840 Fax : +91 20 2729 2839
Email : info@renuelectronics.com
Website: www.renuelectronics.com

An ISO 9001:2008 and ISO 14001:2004 certified company